



Tiara
SPORT

2022 OWNERS MANUAL

38LX

CALIFORNIA PROPOSITION 65 WARNING



WARNING

WARNING: Operating, servicing and maintaining a recreational marine vessel can expose you to chemicals including engine exhaust, carbon monoxide, phthalates, and lead, which are known to the State of California to cause cancer and birth defects or other reproductive harm. To minimize exposure, avoid breathing exhaust, service your vessel in a well-ventilated area and wear gloves or wash your hands frequently when servicing this vessel. For more information go to www.P65warnings.ca.gov/marine.

Per California law, the label below is affixed to your boat's helm console. Should you need a replacement, contact Tiara Yachts customer service and request safety label #5450131.

EMISSIONS CONTROL SYSTEM INFORMATION

MEETS 2022 MY CALIFORNIA EVAP EMISSIONS
REGULATIONS FOR SPARK-IGNITION MARINE WATERCRAFT

MANUFACTURER: **S2 YACHTS, INC.**

CALIFORNIA EVAP FAMILY: **NTRAPVSSL001**

EMISSION CONTROL SYSTEM: **CP**

5450131



Welcome to the family of Tiara Yachts boat owners and congratulations on your purchase of your new Tiara Yacht.

We understand there are many choices available to you, and we appreciate the investment that you've made and the subsequent faith and confidence that you've placed into our product. Hopefully, during the selection and buying process, you discovered that each Tiara has been designed, engineered, and built with care and precision.

When our company was started, it was the goal of my father, Leon Slikkers, to provide you with the finest quality boat available. We want to be the best and deliver the best to you. And part of that includes a delightful ownership experience. Everything we have achieved since our humble beginnings has been with this same goal in mind.

The information within this owner's manual was assembled to assist you in understanding how to operate your boat to obtain the maximum enjoyment of your Tiara Yacht. So please take time to read the manual completely and please operate your boat safely and courteously.

I would also like to ask you a personal favor. Shortly, you will receive a survey asking for your opinion about the sales process you experienced when you purchased your boat. Approximately nine months later, you'll be sent another survey inquiring about your ownership experience. By taking a few minutes to complete these surveys, you will be providing us with valuable information.

Best wishes for many happy hours aboard your new Tiara Yacht,

A handwritten signature in blue ink, appearing to read "T. Slikkers", with a long horizontal flourish extending to the right.

Thomas B. Slikkers
CEO/President S2 Yachts

This page intentionally left blank.

LIMITED WARRANTY

2022 MODELS S2 YACHTS, INC. LIMITED WARRANTY COVERAGE

S2 Yachts, Inc. (S2) provides limited warranty coverage on Tiara Yachts products sold for use by retail (non-commercial) customers, as described in this Limited Warranty. For customers in the U.S.: this warranty gives you specific legal rights; you also may have other rights, which vary from state to state. For customers in the European Union: the purchaser may have additional legal rights under applicable national legislation governing the sale of consumer goods, and those rights (if applicable) are not affected by this warranty.

This warranty is provided only to the original purchaser of the boat from an authorized S2 Yachts dealer, but can be transferred to subsequent owners. Contact S2's Customer Relations Department if you need information about transferring this warranty. No warranty coverage is provided to subsequent owners unless they follow S2's transfer procedures. This warranty does not extend or apply to anyone else. The terms of this written warranty cannot be changed or modified, except by a written agreement signed by an officer of S2 Yachts, Inc.

COVERED PRODUCTS AND LIMITATIONS:

S2's limited warranty coverage applies only to:

1. Defects in materials and workmanship in the boat and all components and accessories (except for the excluded items described below) for a period of two (2) years;
2. Structural defects in materials and workmanship in the hull and deck for a period of five (5) years;
3. Blistering due to defects in material and workmanship in the gelcoat surface of the hull bottom for a period of five (5) years, provided that the gelcoat surface has not been altered in any way such as sanding, sandblasting or application of a coating other than standard antifouling paint, any of which will void this warranty.

Each of the warranty coverage periods runs from the date of purchase of the boat from an authorized S2 Yachts dealer and applies only to warranted defects that first manifest themselves and are reported to S2 within the applicable warranty period. S2 retains the right to determine to its reasonable satisfaction whether any claimed defect is covered by this warranty.

Certain items are excluded from warranty coverage by S2, and this limited warranty coverage does not apply to:

1. Engines, transmissions, generators, air conditioning systems, swim platforms and lifts, seakeeping systems, electronics and batteries. These products may come with separate warranties from their manufacturers; see the Owner Packet for warranty registration requirements and details on these products.
2. Dealer final assembly and pre-delivery commissioning, and dealer installed components.
3. Scratching, chipping, discoloration or flaking of any powder coated or painted surface including engines and hardtop components.
4. Gelcoat stress cracking, chalking, fading or discoloration. This includes bilge gelcoat.
5. Damage caused by accident, wear, storm damage, grounding, towing, commercial use of the boat, or misuse or abuse, or deterioration resulting from normal use (including gaskets, seals, springs, wipers and sealants).
6. Maintenance, adjustments or realignments to any components including latches, hinges, hatches, doors and drive train components.
7. Mold, mildew, upholstery damage or deterioration and cleaning.
8. Damage or deterioration resulting from environmental conditions, including electrolysis, crevice or galvanic corrosion, any deterioration of underwater equipment, or any damage or deterioration resulting from any failure to undertake reasonable, routine maintenance.

9. Any repairs, adjustments, alterations or modifications made by anyone other than an employee of S2 Yachts, or an authorized S2 Yachts dealer with S2's prior, written authorization.
10. Damage which has occurred as a result of the boat being operated as a demonstrator and/or displayed for sale.
11. Damage or deterioration of the hull or deck structure due to the attachment of hardware or other components.
12. Weight, speed, fuel consumption or other performance characteristics.
13. Damage or deterioration resulting from improper trailering, hauling, launching or storage.
14. Boats purchased or used for commercial or governmental purposes or uses.

REMEDIES UNDER THIS LIMITED WARRANTY

If a defect covered by this warranty occurs, S2 (or one of its authorized dealers, as determined by S2) will repair and replace the defective component, in its sole discretion. This 'repair or replacement' remedy is the exclusive remedy under this warranty. S2 has no responsibility or liability for any consequential or incidental damages, such as loss of use, storage charges, interest or finance charges, insurance or depreciation, transportation or lodging charges, or charges for towing or hauling out, etc. which are specifically excluded and disclaimed from this warranty. For customers in the U.S.: some states do not allow the exclusion or limitation of incidental or consequential damages, so the above limitation or exclusion may not apply to you. UNDER CERTAIN APPLICABLE LAWS, THERE MAY BE NO IMPLIED WARRANTIES OR GUARANTEES FROM S2 APPLICABLE TO YOUR BOAT, AND ALL IMPLIED OR STATUTORY CONDITIONS AND WARRANTIES (INCLUDING ANY WARRANTY OF MERCHANTABILITY OR FITNESS FOR A PARTICULAR PURPOSE) AND GUARANTIES ARE DISCLAIMED WHERE ALLOWED BY LAW. TO THE FULLEST EXTENT ALLOWED BY LAW, ANY AND ALL APPLICABLE IMPLIED WARRANTIES AND GUARANTIES (IF ANY), INCLUDING ANY IMPLIED WARRANTY OF MERCHANTABILITY OR PARTICULAR PURPOSE, ARE LIMITED IN DURATION TO THE DURATION OF THE APPLICABLE PROVISIONS OF THIS WRITTEN WARRANTY. For customers in the U.S.: some states do not allow limitations on how long an implied warranty lasts, so the above limitation may not apply to you.

RESPONSIBILITY OF PURCHASER

1. No warranty coverage is provided by S2 unless the customer and dealer complete and return all Vessel Registration and Customer Acceptance Forms to S2 Yachts, Inc. within thirty (30) days after delivery of the boat to the original purchaser.
2. The original purchaser or approved transferee must notify the S2 Yachts dealer from which the boat was purchased of any claimed defect within fifteen (15) days after first detecting the claimed defect. Warranty work in excess of \$500 requires S2's prior written approval.
3. If the dealer fails to satisfactorily repair the claimed defect within fifteen (15) days, written notice must then be promptly given directly to S2. S2 is not responsible for unreported warranted defects.
4. The boat, including any claimed defective part, must be returned to the S2 Yachts dealer from which the boat was purchased (or to another dealer or facility as directed by S2 Yachts) within the warranty period for inspection and warranty service. The expense of returning and transporting the boat or any part for warranty service, and the expense of returning and transporting it back to the owner after repair or replacement, is the responsibility of the owner, and will not be reimbursed by S2.
5. If the dealer from whom the boat was purchased is no longer an authorized S2 Yachts dealer, contact S2 for instructions on how to obtain warranty service.

S2 reserves the right to improve its products through changes in design or materials without being obligated to the owners of the boats of similar or the same model of prior manufacture. We may be contacted as follows: Tiara Customer Relations Department, 725 East 40th Street, Holland, Michigan 49423 (616/394-7460).



SUPPLEMENTAL LIMITED WARRANTY INFORMATION ON FINISHED WOOD COMPONENTS

Your Tiara Yachts® Boat may be furnished with certain finished wood panels and components that require periodic maintenance and refinishing to maintain their appearance and finish. S2 Yachts, Inc.'s Limited Warranty coverage does not include the matching of wood grains, or the condition or durability of any finishes for such panels and components. This statement supplements S2 Yachts, Inc.'s Limited Warranty with respect to these wood panels and components. All other terms of S2 Yachts, Inc.'s Limited Warranty remain in effect, and you should refer to the Limited Warranty for other terms, conditions and requirements

CALIFORNIA EVAPORATIVE EMISSIONS CONTROL SYSTEM WARRANTY STATEMENT: YOUR WARRANTY RIGHTS AND OBLIGATIONS

The California Air Resources Board and S2 Yachts, Inc. is pleased to explain the evaporative emission control system's warranty on your 2022 model year spark-ignition marine watercraft. In California, new spark-ignition marine watercraft (SIMW) must be designed, built, and equipped to meet the State's stringent anti-smog standards. S2 Yachts, Inc. must warrant the evaporative emission control system on your spark-ignition marine watercraft for the period listed below provided there has been no abuse, neglect, or improper maintenance of your SIMW.

Your evaporative emissions control system may include parts such as: canisters, carburetors, clamps, connectors, filters, fuel caps, fuel lines, fuel tanks, valves, vapor hoses, and other associated evaporative emissions control system components.

MANUFACTURER'S WARRANTY COVERAGE:

This evaporative emission control system is warranted for two years. If any evaporative emission-related part on your SIMW is defective, the part will be repaired or replaced by S2 Yachts, Inc.

OWNER'S WARRANTY RESPONSIBILITIES:

- As the spark-ignition marine watercraft owner, you are responsible for performance of the required maintenance listed in your owner's manual. S2 Yachts, Inc. recommends that you retain all receipts covering maintenance on your spark-ignition marine watercraft, but S2 Yachts, Inc. cannot deny warranty solely for the lack of receipts.
- As the spark-ignition marine watercraft owner, you should however be aware that S2 Yachts, Inc. may deny you warranty coverage if your spark-ignition marine watercraft or a part has failed due to abuse, neglect, or improper maintenance or unapproved modifications.
- You are responsible for presenting your spark-ignition marine watercraft to a S2 Yachts, Inc. dealer or authorized service center as soon as the problem exists. The warranty repairs should be completed in a reasonable amount of time, not to exceed 30 days. If you have a question regarding your warranty coverage, you should contact S2 Yachts, Inc. at 1-616-392-7163.

The California evaporative emissions control system warranty covers the following list of components:

- | | |
|-------------------------------------|--|
| (1) Canister Mounting Brackets | (12) Fuel Line Fittings |
| (2) Carbon Canister | (13) Fuel Tank |
| (3) Carburetor Purge Port Connector | (14) Liquid/Vapor Separator |
| (4) Clamps* | (15) Pressure Relief Valves* |
| (5) Control Cables* | (16) Purge Valves |
| (6) Control Linkages* | (17) Vacuum Control Diaphragms* |
| (7) Control Solenoids* | (18) Vapor Hoses |
| (8) Control Valves* | (19) All other parts not listed that may affect the evaporative emissions control system |
| (9) Electronic Controls* | |
| (10) Fuel Cap | |
| (11) Fuel Line | |

*Note: As they relate to the evaporative emissions control system.

Safety Information

Your owner's manual was written to include safety instructions to ensure safe operation and maintenance of your boat. This manual uses safety symbols to alert you to potential personal injury hazards.

 **DANGER**

Indicates a hazardous situation which, if not avoided, will result in death or serious injury.

 **WARNING**

Indicates a hazardous situation which, if not avoided, could result in death or serious injury.

 **CAUTION**

Indicates a hazardous situation which, if not avoided, could result in minor or moderate injury.

 **NOTICE**

Indicates a potentially hazardous situation which, if not avoided, may result in property damage.

All instructions in this manual should be viewed from the stern looking toward the bow, with starboard to your right and port to your left. A glossary of boating terms is included.

Your boat produces carbon monoxide (CO) and uses flammable fuel. Carbon monoxide gas (CO) is colorless, odorless and extremely dangerous. CO will cause BRAIN DAMAGE or DEATH.

Every precaution has been taken by S2 Yachts to reduce the risks associated with death, possible injury and damage from fire or explosion. Your own precaution and good maintenance procedures are necessary in order to enjoy safe operation of your boat.

 **DANGER**

Exposure to carbon monoxide will cause death or serious injury. Avoid direct and prolonged exposure to CO.

Gasoline and other fuels are extremely flammable and highly explosive under certain conditions.

- DO NOT smoke or allow open flame or sparks nearby when fueling.
- DO NOT block fuel vents.
- DO NOT store fuel in any containers or compartments which are not designated for storing fuel.

Table of Contents

Safety Labels

Interior	1
Exterior	2
Safety Label Locations	4

General Information

Engine and General Specifications	9
Boat Information	10

Pre-Cruise Checklist

Fire Extinguisher Locations	13
Pre-Cruise Checklist.....	13

Propulsion Systems

1.1 General.....	1-1
1.2 Saltwater Application	1-1
1.1 Engine Lubrication.....	1-2
1.2 Engine Cooling System	1-2
1.3 Propellers	1-2
1.4 Engine Instrumentation.....	1-2
1.5 Seakeeper Gyro Stabilization System (optional).....	1-3

Helm Systems

2.1 General.....	2-1
2.2 Helm Access.....	2-1
2.3 Engine Monitoring Displays.....	2-1
2.4 Engine Throttle and Shift Controls.....	2-1
2.5 Neutral Safety Switch	2-2
2.6 Automatic Fire Suppression System	2-2
2.7 Engine Stop Switch	2-3
2.8 Engine Power Tilt and Trim.....	2-3
2.9 Steering System	2-4
2.10 Trim Tabs	2-5
2.11 Compass.....	2-6
2.12 Bow Thruster	2-6
2.13 Joystick.....	2-6
2.14 Spotlight (optional).....	2-7

Fuel Systems

3.1 General.....	3-1
3.2 Fuel System.....	3-1
3.3 Diesel Generator Fuel System	3-4
3.4 Fuel System Maintenance.....	3-6
3.5 Oil Change System (optional).....	3-7

Electrical Systems

4.1 General.....	4-1
4.2 12-Volt DC System	4-1
4.3 Master DC Panel Breakers	4-2
4.4 12-Volt DC Helm Switches	4-3
4.5 DC Distribution Panel	4-4
4.6 Seakeeper Gyro (optional)	4-5
4.7 AC System.....	4-5
4.8 AC Distribution Panel.....	4-6
4.9 Other Electrical Controls.....	4-7
4.10 Shore Power Connection.....	4-7
4.11 Generator.....	4-9
4.12 Electrical System Maintenance	4-10

Plumbing Systems

5.1 Freshwater System.....	5-1
5.2 Freshwater System Commissioning	5-2
5.3 Marine Head System	5-4
5.4 Washdowns (optional).....	5-7
5.5 Drainage	5-8
5.6 Plumbing System Maintenance.....	5-9

Ventilation Systems

6.1 Air Conditioning System (optional)	6-1
6.2 Portlights	6-1
6.3 Carbon Monoxide	6-2
6.4 Bilge Ventilation.....	6-2
6.5 Maintenance	6-2

Table of Contents

Exterior Equipment

7.1 Forward Deck	7-1
7.2 Centerline Walkway	7-3
7.3 Mid Cockpit.....	7-4
7.4 Shore Power Connection.....	7-5
7.5 Mid Cockpit Galley.....	7-6
7.6 Hardtop	7-7
7.7 Aft Cockpit	7-7
7.8 Stern	7-8

Interior Equipment

8.1 Safety Equipment.....	8-1
8.2 Companionway.....	8-1
8.3 Berth (optional).....	8-1

Safety Information

9.1 General.....	9-1
9.2 Engine Alarms	9-1
9.3 Neutral Safety Switch	9-1
9.4 Engine Stop Switch	9-1
9.5 Fire Safety	9-2
9.6 Carbon Monoxide Safety	9-4
9.7 First Aid.....	9-6
9.8 Required Safety Equipment.....	9-6
9.9 Additional Safety Equipment.....	9-8

Operation

10.1 General.....	10-1
10.2 Homeland Security Restrictions	10-2
10.3 Rules of the Road.....	10-2
10.4 Operating your Boat	10-3
10.5 Docking, Anchoring, and Mooring.....	10-5
10.6 Controls, Steering, or Propulsion System Failure	10-7

10.7 Collision.....	10-7
10.8 Grounding, Towing, and Rendering Assistance.....	10-7
10.9 Flooding or Capsizing.....	10-8
10.10 Transporting your Boat	10-8
10.11 Man Overboard.....	10-8
10.12 Trash Disposal.....	10-9
10.13 Multi-Colored Lighting.....	10-9

Routine Maintenance

11.1 General.....	11-1
11.2 Exterior Hull and Deck	11-1
11.3 Seats and Upholstery	11-5
11.4 Cabin Interior	11-6
11.5 Bilge.....	11-6
11.6 Electrical	11-6
11.7 Generator.....	11-6

Seasonal Maintenance

12.1 Winterizing.....	12-1
12.2 Storage and Lay-up	12-3
12.3 Recommissioning	12-5

Appendices

Glossary of Terms.....	A-1
Maintenance Guides.....	B-1
Maintenance Schedule.....	C-1
Boating Accident Report.....	D-1
Float Plan	E-1
Troubleshooting Guide	F-1
Schematics.....	G-1

Safety Labels

The following diagrams indicate where safety labels can be found on your Tiara Yacht. Numbers correspond to the table that follows, which lists the replacement part number (P/N) for each label. To obtain replacement labels, contact your Tiara Yachts dealer.

Interior





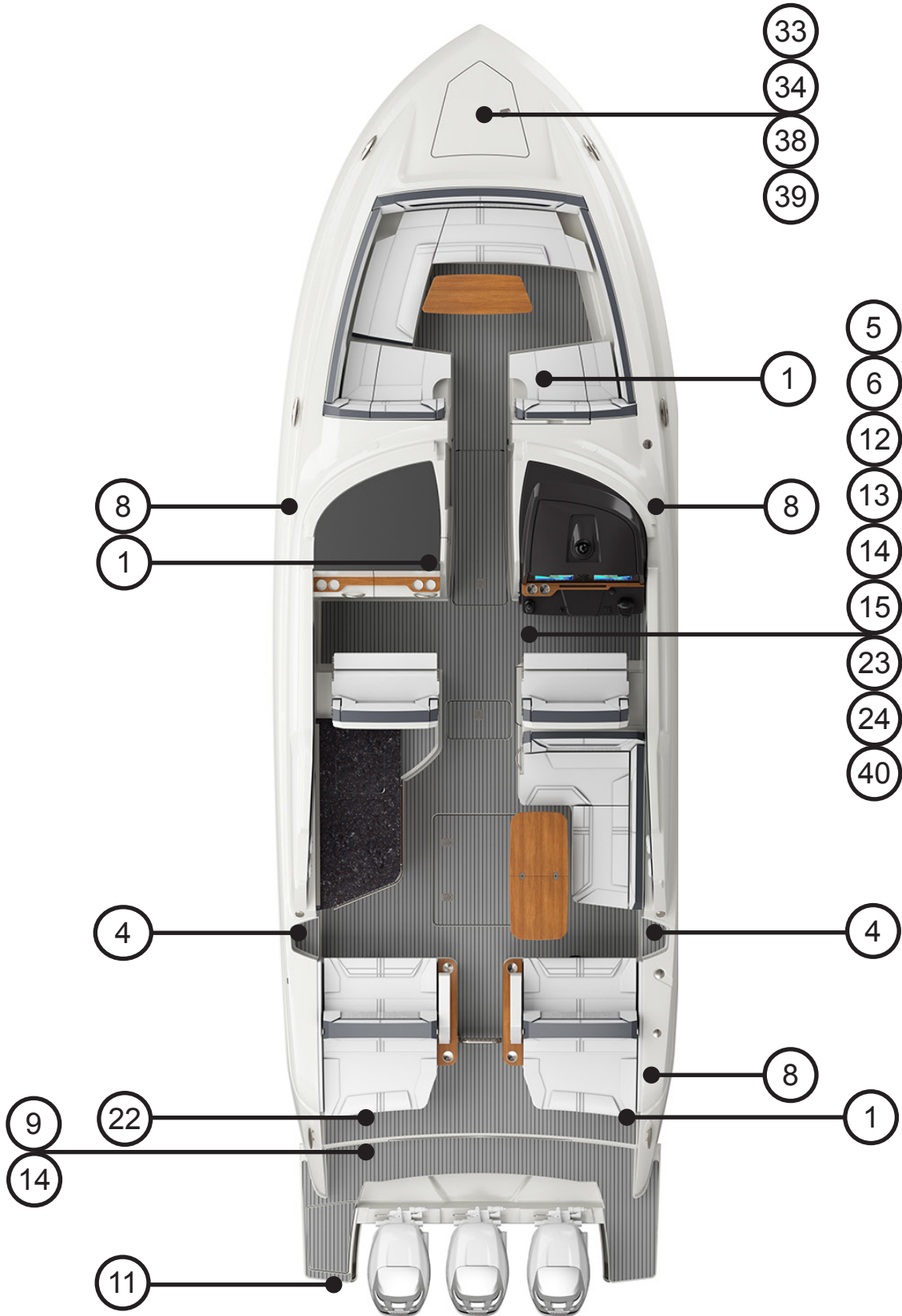



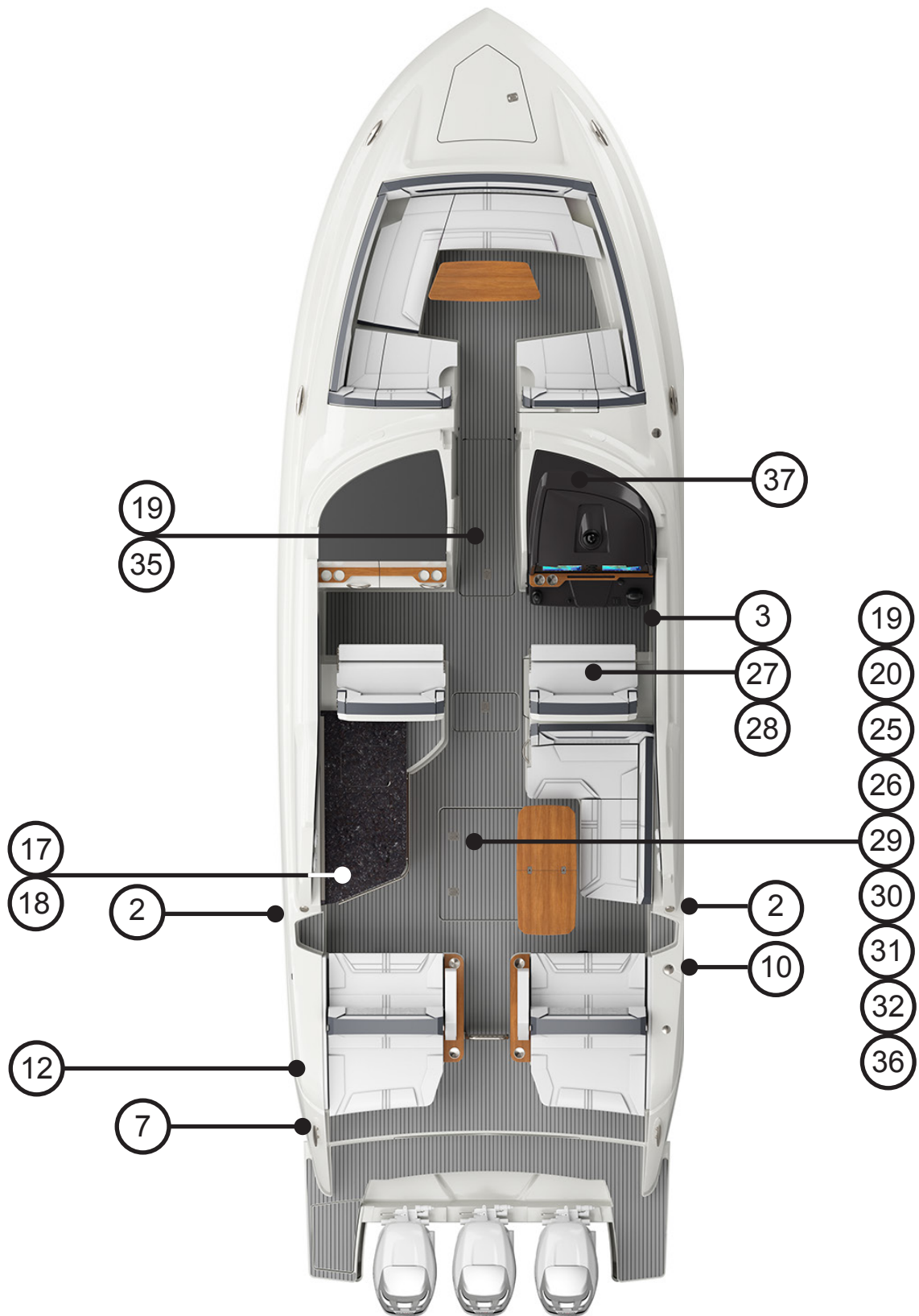

Exterior





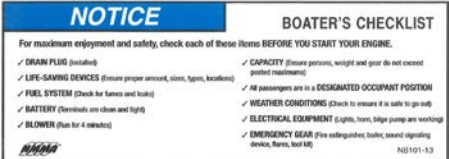



Safety Labels



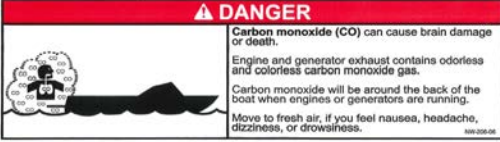





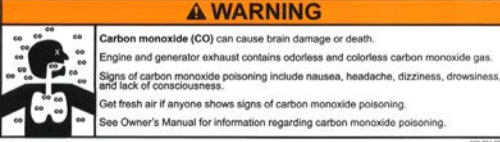
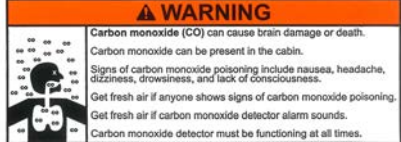

Safety Labels

1	<p>FIRE EXTINGUISHER INSIDE P/N: 5452010</p> <p>Location: Forward toy storage compartment/ optional berth; head compartment companionway; starboard aft seat base</p>	
2	<p>NO SMOKING P/N: 5451130</p> <p>Location: Port & starboard fuel fills</p>	
3	<p>NOTICE: FIRE EXTINGUISHING SYSTEM P/N: 5453300</p> <p>Location: Outboard of the helm seat</p>	
4	<p>UNSAFE BOAT HAZARD P/N: 5450081</p> <p>Location: Outboard of the port and starboard lounge seats</p>	
5	<p>BOATERS CHECK LIST P/N: 5450120</p> <p>Location: Helm</p>	
6	<p>YACHT CERTIFICATION PLATE P/N: 5450052</p> <p>Location: Helm</p>	
7	<p>NMMA CERTIFIED P/N: 5455250</p> <p>Location: Port transom wing</p>	
8	<p>SLING P/N: 5450240</p> <p>Location: Port & starboard hull sides</p>	



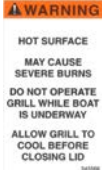

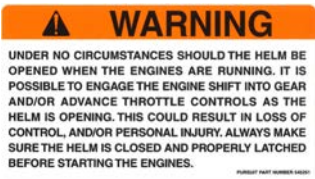

Safety Labels

9	<p>DANGER: CARBON MONOXIDE P/N: 5453650 Location: Under aft cockpit U-lounge at port transom walkway</p>	 <p>⚠ DANGER Carbon monoxide (CO) can cause brain damage or death. Engine and generator exhaust contains odorless and colorless carbon monoxide gas. Carbon monoxide will be around the back of the boat when engines or generators are running. Move to fresh air, if you feel nausea, headache, dizziness, or drowsiness. NW-201-08</p>
10	<p>WARNING: FILL WITH DIESEL ONLY P/N: 5454580 Location: Starboard diesel fuel fill</p>	
11	<p>WARNING: SEAT USE WHILE UNDERWAY P/N: 5455875 Location: Forward sun lounge (bottom of windshield in center)</p>	 <p>⚠ WARNING Occupying this seat/lounge while underway can result in serious injury or death. Do not use this seat/lounge while vessel is underway. 5455875</p>
12	<p>WARNING: CLOSE TRANSOM DOOR P/N: 5453220 Location: Helm, and near transom gate</p>	 <p>⚠ WARNING Falling overboard can result in serious injury or drowning. Keep transom door(s) and gate closed while boat is under way. 5453222</p>
13	<p>WARNING: LEAKING FUEL P/N: 5450060 Location: Helm</p>	 <p>⚠ WARNING AVOID SERIOUS INJURY OR DEATH FROM FIRE OR EXPLOSION RESULTING FROM LEAKING FUEL. INSPECT SYSTEM FOR LEAKS AT LEAST ONCE A YEAR. NW-201-14</p>
14	<p>WARNING: ROTATING PROPELLERS P/N: 5451180 Location: Helm & port transom walkway</p>	 <p>⚠ WARNING Moving propellers are dangerous. Can cause death, loss of limbs, or other severe injury. Do not use swim platform or swim ladder while the engine(s) are running. Stop engines if skiers/swimmers are attempting to board. 5451180</p>
15	<p>WARNING: CARBON MONOXIDE P/N: 5453690 Location: Helm</p>	 <p>⚠ WARNING Carbon monoxide (CO) can cause brain damage or death. Engine and generator exhaust contains odorless and colorless carbon monoxide gas. Signs of carbon monoxide poisoning include nausea, headache, dizziness, drowsiness, and lack of consciousness. Get fresh air if anyone shows signs of carbon monoxide poisoning. See Owner's Manual for information regarding carbon monoxide poisoning. NW-201-08</p>
16	<p>WARNING: CARBON MONOXIDE P/N: 5453680 Location: Optional forward berth (if equipped)</p>	 <p>⚠ WARNING Carbon monoxide (CO) can cause brain damage or death. Carbon monoxide can be present in the cabin. Signs of carbon monoxide poisoning include nausea, headache, dizziness, drowsiness, and lack of consciousness. Get fresh air if anyone shows signs of carbon monoxide poisoning. Get fresh air if carbon monoxide detector alarm sounds. Carbon monoxide detector must be functioning at all times. NW-201-08</p>

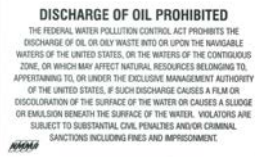
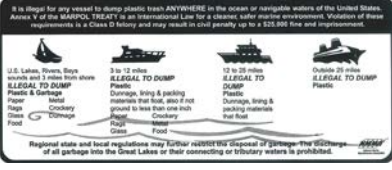



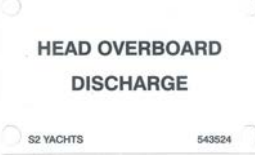

Safety Labels

17	<p>WARNING: SUNSHADE STOWAGE P/N: 5450054 Location: Underside of port hardtop</p>	
18	<p>WARNING: HARDTOP P/N: 5453160 Location: Underside of port hardtop</p>	
19	<p>WARNING: FUEL VAPORS P/N: 5455950 Location: Ski locker and mid-cockpit floor storage hatches</p>	
20	<p>WARNING: DO NOT DRILL P/N: 5400081 Location: Mechanical space bulkheads</p>	
21	<p>WARNING: GRILL SHOCK AND FIRE P/N: 5455680 Location: Underside of grill lid</p>	
22	<p>WARNING: HAZARDOUS VOLTAGE P/N: 5451110 Location: Port shore power cord outlet</p>	
23	<p>WARNING: CLOSE HELM BEFORE STARTING P/N: 5452510 Location: Helm</p>	
24	<p>TAG: CALIFORNIA PROP 65 P/N: 9253280 Location: Steering Wheel</p>	

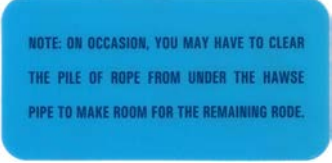
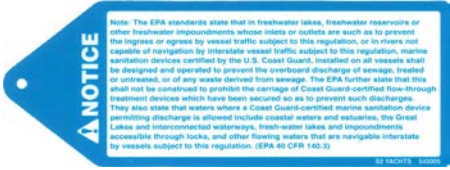
Safety Labels

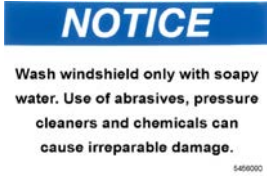
25	<p>DISCHARGE OF OIL PROHIBITED P/N: 5450190 Location: Underside of mechanical space hatch</p>	 <p>DISCHARGE OF OIL PROHIBITED THE FEDERAL WATER POLLUTION CONTROL ACT PROHIBITS THE DISCHARGE OF OIL OR OILY WASTE INTO OR UPON THE NAVIGABLE WATERS OF THE UNITED STATES, OR THE WATERS OF THE CONTIGUOUS ZONE, OR WHICH MAY AFFECT NATURAL RESOURCES BELONGING TO, OR BELONGING TO, OR UNDER THE EXCLUSIVE MANAGEMENT AUTHORITY OF THE UNITED STATES, IF SUCH DISCHARGE CAUSES A FILM OR DISCOLORATION OF THE SURFACE OF THE WATER OR CAUSES A SLUDGE OR EMULSION BENEATH THE SURFACE OF THE WATER. VIOLATORS ARE SUBJECT TO SUBSTANTIAL CIVIL PENALTIES AND/OR CRIMINAL SANCTIONS INCLUDING FINES AND IMPRISONMENT.</p>
26	<p>DUMPING TRASH OVERBOARD P/N: 5451640 Location: Mechanical space hatch</p>	 <p>It is illegal for any vessel to dump plastic trash ANYWHERE in the ocean or navigable waters of the United States. Annex V of the MARPOL TREATY is an international law for a cleaner, safer marine environment. Violation of these requirements is a Class B felony and may result in total penalty up to a \$25,000 fine and imprisonment.</p> <p>U.S. Lakes, Rivers, Bays, Woods and 3 miles from shore ILLEGAL TO DUMP Plastic & Garbage Paper Rags Glass Food</p> <p>3 to 12 miles ILLEGAL TO DUMP Plastic Dunnage, lashing & packing materials that break apart Ground to less than one inch Rags Glass Food</p> <p>12 to 25 miles ILLEGAL TO DUMP Plastic Dunnage, lashing & packing materials that break apart</p> <p>Outside 25 miles ILLEGAL TO DUMP Plastic</p> <p>Regional state and local regulations may further restrict the disposal of garbage. The discharge of all garbage into the Great Lakes or their connecting or tributary waters is prohibited.</p>
27	<p>FRESH WATER (optional) P/N: 5450260 Location: Under the helm seat</p>	 <p>FRESH WATER 545026</p>
28	<p>RAW WATER (optional) P/N: 5450270 Location: Under the helm seat</p>	 <p>RAW WATER 545027</p>
29	<p>TAG: GENERATOR PICKUP P/N: 5435210 Location: Mechanical space</p>	 <p>GENERATOR PICKUP S2 YACHTS 543521</p>
30	<p>TAG: HEAD OVERBOARD DISCHARGE P/N: 5435240 Location: Forward storage compartment under ski locker sole</p>	 <p>HEAD OVERBOARD DISCHARGE S2 YACHTS 543524</p>
31	<p>TAG: AIR CONDITIONING PICKUP P/N: 5435250 Location: Mechanical space</p>	 <p>AIR CONDITIONING PICKUP S2 YACHTS 543525</p>
32	<p>TAG: WASHDOWN PICKUP P/N: 5435260 Location: Mechanical space</p>	 <p>WASHDOWN PICKUP S2 YACHTS 543526</p>

Safety Labels

33	<p>WARNING: WINDLASS P/N: 5455960 Location: Anchor locker hatch</p>	
34	<p>NOTICE: ANCHOR RODE P/N: 5455970 Location: Anchor locker hatch</p>	
35	<p>TAG: OVERBOARD DISCHARGE OF SEWAGE P/N: 5450050 Location: Forward storage compartment under ski locker sole</p>	
36	<p>TAG: BATTERY MOUNTING REQUIREMENTS P/N: 5450160 Location: Battery compartment</p>	
37	<p>NOTICE: WINDSHIELD CLEANING P/N: 5456090 Location: Inside windshield top starboard</p>	
38	<p>NOTICE: ANCHOR LINE LOSS P/N: 5453180 Location: Underside of anchor hatch</p>	
39	<p>NOTICE: GELCOAT DAMAGE P/N: 5450720 Location: Anchor locker hatch</p>	
40	<p>NOTICE: KEEP HATCHES CLOSED P/N: 5455660 Location: Helm</p>	

General Information

Engine and General Specifications

Maximum Horsepower.....	1,050 HP (783 kw)
L.O.A. with integrated platform.....	38'1" (11.6 meters)
Beam	12'6" (3.81 meters)
Draft (fully loaded, motors down).....	3'4" (1 meter)
Draft (motors up)	2'3" (69 centimeters)
Clearance with Hardtop (from waterline).....	9'2" (2.79 meters)
Approximate Dry Weight.....	18,600 lbs. (8,437 kg)
Fuel Capacity.....	330 U.S. gallons (1,253 liters)
Water Capacity	50 U.S. gallons (189 liters)
Holding Tank Capacity	27 U.S. gallons (102 liters)
Diesel Capacity (generator).....	30 U.S. gallons (114 liters)
Deadrise at Transom	20°

General Information

Boat Information

Fill out the following information and leave it in your Tiara Owner's Manual. This information will be important for you and Tiara service personnel to know, if and when you may need to call Tiara for technical assistance or service.

Boat		
Model: Tiara Yachts 38 LX	Hull Identification #:	
Purchase Date:	Delivery Date:	
Ignition Keys:	Registration #:	
Engines		
Port Engine	Center Engine	Starboard Engine
Make:	Make:	Make:
Model:	Model:	Model:
Engine Serial Number:	Engine Serial Number:	Engine Serial Number:
Lower Unit Serial Number:	Lower Unit Serial Number:	Lower Unit Serial Number:
Propellers		
Make:	Diameter / Pitch:	
Blades:	Other:	
Generator		
Make:	Model:	
Serial #:	kW:	
Dealer	Tiara	
Name:	Phone #:	
Phone #:	Representative:	
Sales Associate:	Address:	
Service Manager:		
Address:		

Tiara Yachts reserves the right to make changes and improvements in equipment, design and vendor supplied equipment at any time without notification.

General Information

Warranty & Warranty Registration Cards

The S2 Yachts, Inc., Limited Warranty Statement is included with this manual. It has been written to be clearly stated and easily understood. If you have any questions after reading the warranty, please contact Tiara Customer Relations.

S2 Yachts, engine manufacturers, and the suppliers of major components maintain their own manufacturer's warranty and service facilities. It is important that you properly complete the warranty registration cards included with your boat and engine(s) and mail them back to the manufacturers to register your ownership. This should be done within 15 days of the date of purchase and before the boat is put into service. A form for recording this information is provided at the beginning of this manual. This information will be important for you and service personnel to know, if and when you may need service or technical information.

The boat warranty registration requires the **Hull Identification Number (HIN)** which is located on the starboard side of the transom, just below the rub rail. The engine warranty registration requires the engine serial number(s). Refer to the engine owner's manual for the location of the serial number(s).

Federal Boat Safety Act

All boat manufacturers are required by the Federal Boat Safety Act of 1971 to notify first-time owners in the event any defect is discovered "which creates a substantial risk of personal injury to the public." It is essential that we have your warranty registration card, complete with your name and mailing address, in our files so that we can comply with the law if it should become necessary.

Product Changes

S2 Yachts is committed to the continuous improvement of our boats. As a result, some of the equipment described in this manual or

pictured in the catalog may change or no longer be available.

S2 Yachts **reserves the right to change standard equipment, optional equipment, and specifications without notice or obligation.** If you have questions about the equipment on your Tiara Yacht, please contact Tiara Customer Relations.

Transferring the Warranty

For a transfer fee, S2 Yachts will extend warranty coverage to subsequent owners of Tiara Yachts models for the duration of the original warranty period. Please refer to the Tiara Limited Warranty Statement for the procedure to transfer the warranty. To take advantage of this program, notification of the change of ownership, including the new owner's name, address, and telephone number together with the appropriate fee, must be sent to Tiara Yachts within 30 days of the date of resale. Contact Tiara Customer Relations for details.

S2 Yachts will confirm, in writing, that the transfer of the warranty has taken place, after which the transferee will be treated as the original purchaser as outlined in the Tiara Limited Warranty Statement.

Owner/Operator Responsibilities

Registration and Documentation

Federal law requires all undocumented vessels equipped with propulsion machinery be registered in the state of principal use. A certificate of documentation will be issued upon registration. These registration numbers must be displayed on your boat. The owner/operator of a boat must carry a valid certificate of registration whenever the boat is in use. When moved to a new state of principal use, the certificate is valid for 60 days.

In order to be valid, the numbers must be installed to the proper specifications. Check with your dealer or state boating authority for numbering requirements. The Coast Guard issues the certificate of number in Alaska; all others are issued by the state.

Insurance

In most states the boat owner is legally responsible for damages or injuries the boat causes. Responsible boaters carry adequate liability and property damage insurance for their boat. You should also protect the boat against physical damage and theft. Some states have laws requiring minimum insurance coverage. Contact your dealer or state boating authority for information on the insurance requirements in your boating area.

Reporting Boating Accidents

All boating accidents must be reported by the owner or operator of the boat to the proper marine law enforcement authority for the state in which the accident occurred. Immediate notification is required if a person dies or disappears as a result of a recreational boating accident.

If a person dies or there are injuries requiring more than first aid, a formal report must be filed within 48 hours.

A formal report must be made within 10 days for accidents involving more than \$500.00 damage or the complete loss of a boat.

A "Boating Accident Report" form is located near the back of this manual to assist you in reporting an accident. For additional information, visit www.uscgboating.org.

Education

If you are not an experienced boater, we recommend that you and other people that normally accompany you enroll in a boating safety course. Organizations such as the U.S. Power Squadrons, United States Coast

Guard Auxiliary, state boating authorities, and the American Red Cross offer excellent boating educational programs. These courses are worthwhile even for experienced boaters to sharpen your skills or bring you up-to-date on current rules and regulations. They can also help in providing local navigational information when moving to a new boating area. Contact your dealer or state boating authority, or visit www.uscgboating.org for further information on boating safety courses.

Required Equipment

U.S. Coast Guard regulations require certain equipment on each boat. The Coast Guard also sets minimum safety standards for vessels and associated equipment. To meet these standards some of the equipment must be Coast Guard approved. "Coast Guard Approved Equipment" has been determined to be in compliance with USCG specifications and regulations relating to performance, construction or materials. The equipment requirements vary according to the length, type of boat, and the propulsion system. Some of the Coast Guard equipment is described in section 9, Safety Information. For more information, visit www.uscgboating.org or contact your local marine dealer or retailer.

Some state and local agencies go beyond USCG regulations or impose similar equipment requirements on waters that do not fall under Coast Guard jurisdiction. Contact your dealer or local boating authority for additional information regarding the equipment requirements for that boating area.

EPA Compliant Fuel System

EPA (Environmental Protection Agency) regulations require additional emissions related components for the fuel tank, fuel fill and fuel vent systems. It is unlawful to remove or intentionally defeat these emission related components.

Pre-Cruise Checklist

Fire Extinguisher Locations

This boat is equipped with a fire suppression system. See section 9, Safety Equipment, for more information.

There are three (3) fire extinguishers installed on this boat. Make sure they are fully charged. Fire extinguishers are located:

- inside the starboard foredeck toy storage/optional berth compartment
- on the head compartment companion-way steps
- in the aft cockpit starboard transom seat base

Pre-Cruise Checklist

Before casting off on your voyage, ensure that proper safety gear is aboard. Familiarize yourself with all engine controls, steering operation, starting procedure, and how to interface with the helm multi-function displays (MFDs) and other instrumentation. Understand local regulations and waterways, and review the contents of this owner's manual before casting off.

Before your voyage:

- Check the weather forecast. Decide if your planned cruise can be made safely.
- Make sure all required documents are onboard.
- Make sure all necessary safety equipment (items like running lights, spotlight, life saving devices, etc.) is onboard and operative. Refer to section 9, Safety Information, for additional information.
- Each person onboard must have at least one personal flotation device. Check the U.S. Coast Guard standards for the correct type required for your boat.
- Make sure signal kits are onboard, in good operating condition, and not expired.
- Make sure all fire extinguishers are in position and in good operating condition.
- Make sure you have sufficient water and

other provisions for the planned cruise.

- Leave a written message listing details of your planned cruise (Float Plan) with a friend ashore. Include a description of your boat, where you intend to cruise, schedule of your arrival in the cruising area, and when you expect to return. Keep the person informed of any changes in your plan to prevent false alarms. This information can tell authorities where to look and your boat type in the event you fail to arrive.
- Check the amount of fuel onboard. Observe the "rule of thirds": one third of the fuel for the trip out, one third to return and one third in reserve. An additional 15% may be consumed in rough seas.
- Check the water-separating fuel filters for water.
- Turn on the battery switches.
- Check for bilge water and for other signs of potential problems. Monitor for the scent of fuel fumes.
- Test the automatic and manual bilge pump switches to make sure the system is working properly.
- Have a tool kit and spare parts onboard (see below).

Before starting the engines:

- Make sure the shift control is in NEUTRAL.
- Make sure the emergency engine stop lanyard is attached to the operator and the stop switch.

See section 10, Operation, for additional important information regarding how to safely operate your boat.

Tool kit

Have a tool kit and spare parts onboard. **The kit should include basic tools:**

- Spark plug wrench
- Hammer
- Spark plug gap gauge

Pre-Cruise Checklist

- Electrician's tape
- Screwdrivers
- Lubricating Oil
- Pliers
- Jackknife
- Adjustable wrench
- Vise grip pliers
- Needle nose pliers
- Wire crimping tool
- End wrench set
- Wire connector set

The spare parts kit should include:

- Extra light bulbs
- Spark plugs
- Fuses and circuit breakers
- Flashlight and batteries
- Drain plugs
- Engine oil
- Propellers
- Fuel filters
- Propeller nuts
- Fuel hose and clamps

Propulsion Systems

1.1 General

Your Tiara Yacht is designed to be powered with outboard engines. The manufacturer of the outboard engines provides an owner’s information manual. It is important you read and understand the information and become familiar with the warranty, operation, and maintenance of the engines and drive systems.

 **WARNING**

MOVING PARTS HAZARD
Contact with moving parts can entangle, cut and cause death or serious injury. DO NOT get close enough to make contact with any running machinery moving parts, i.e., engine or propeller. Contact can result in loss of body parts, strangulation, burns and/or severe loss of blood resulting in death or serious injury.

 **NOTICE**

DO NOT attempt to service any part of the outboard or boat systems unless you are familiar or qualified to do so. Do not use parts which are not designed for a marine application.

 **NOTICE**

Use only the fuel recommended by the engine manufacturer. Use of old, contaminated fuel can cause the engine to malfunction or severe damage.

1.2 Saltwater Application

Each outboard engine is a complete drive system with the gear case (transmission) forward of the propeller and connected to the power head with a vertical drive shaft. Other than the routine maintenance outlined in the engine owner’s manual, there is little to be concerned with unless the boat is to be kept in saltwater for extended periods. Marine growth will occur when components are left in the water for extended periods and can cause poor performance or permanent damage to the exposed components. The type of growth and how quickly it occurs is relative to the water conditions in your boating area. Water temperature, pollution, current, etc., can have an effect on marine growth.

Galvanic corrosion is the corrosion process occurring when different metals are submerged in an electrolyte. Sea water is an electrolyte and submerged engine components must be properly protected. Outboard engines are equipped with sacrificial anodes to help prevent galvanic corrosion problems. The anodes must be monitored and replaced as necessary. For locations and maintenance, refer to the engine owner’s manual.

When leaving the boat in the water, tilt the motors as high as possible to decrease the risk of damage from galvanic corrosion or marine growth around the cooling inlets, propeller and exhaust ports.

 **CAUTION**

DO NOT use copper-based coatings or any coatings not approved for use with aluminum. Some paint manufacturers claim their paints are safe for aluminum. Copper components and copper-based paints can cause severe corrosion to aluminum. DO NOT use copper-based paints. Mercury or mercury-based compounds that come into contact with aluminum will result in severe corrosion.

1.1 Engine Lubrication

Four-cycle engines have an oil sump in the crankcase. Use the oil type, grade, and level recommended by the engine manufacturer. It is normal for 4-cycle engines to consume a small amount of oil. Check the oil level before each use and change it following the engine manufacturer's recommendation.

Refer to section 3, Fuel Systems, and the engine owner's manual for oil specifications and additional information on the oil injection system.

NOTICE

Use only the oil recommended by the engine manufacturer, and monitor the oil level. Use of any other type of oil can cause severe damage or engine malfunction.

1.2 Engine Cooling System

Outboard engines are raw water (sea water) cooled. Water is pumped through the water inlets, circulated through the engine block, and expelled with the exhaust through the exhaust port, water port and propeller hub. The water pump uses a small impeller made of synthetic rubber. The impeller and water pump cannot run dry for more than a few seconds. In most outboard engines, some cooling water is diverted through the ports below the engine cowling. This allows the operator to visually check the operation of the cooling system. When the engine is started, make sure a steady stream of water is present.

If the boat is used in salt or badly polluted water, flush the engines after each use to reduce corrosion. Refer to your engine package owner's manual for the proper engine flushing procedure.



CAUTION

DO NOT operate an engine out of the water, even momentarily. Water must be supplied to the cooling system of the power head and water pump, or serious damage will result. If it is necessary to run the engine out of the water, connect it to an engine flush attachment designed for your specific engine.

1.3 Propellers

The propellers convert the power of the engines into thrust. Propellers vary in style, diameters and pitch. The best set for your needs will depend on your application and expected average load. Propeller sizes are identified by two numbers stamped on the prop in sequence; the first is the diameter and the second is the pitch (example 14 x 21). Pitch is the theoretical distance the propeller will travel in one rotation.

Repair or replace a propeller immediately if it has been damaged. A damaged propeller can cause vibration that can be felt in the boat and can damage the engine gear case. Refer to the engine owner's manual for information on propeller removal and installation.

1.4 Engine Instrumentation

The helm is equipped with two multi-function displays (MFDs). The MFDs allow the operator to monitor all engine functions (including fuel level and engine trim), operate the engines most efficiently, and prevent serious costly damage. The exact instrumentation is unique to the type of outboard engines installed on your boat. Refer to your engine package owner's manuals for more information.

Your boat is equipped with a monitoring display supplied by the manufacturer of your engine package. Refer to the engine owner's manual for more information.



CAUTION

If an engine alarm sounds, shut off the engine, investigate the problem and correct it.



NOTICE

DO NOT exceed maximum recommended engine RPM. Exceeding, maintaining or coming close to maintaining maximum RPM can reduce engine life.



NOTICE

Continued operation of an overheated engine will cause severe engine damage. If the engine overheats, shut off the engine, investigate the problem, and correct it.

1.5 Seakeeper Gyro Stabilization System (optional)

To operate the optional Seakeeper® Gyro Stabilization System, if installed, use the control panel located on the helm. Refer to section 4, Electrical Systems, and the Seakeeper user manual for more information.

Helm Systems

2.1 General

The helm controls consist of engine throttle and shift controls, steering system, trim tab control switches, and either joystick or bow thruster controls.

The manufacturer of each control component provides an owner’s manual with its product. It is important that you read, understand, and become familiar with the proper care and operation of all control systems.

For information about the DC component buttons on the helm, see section 4, Electrical Systems.

2.2 Helm Access

The helm station is hinged at the bottom and opens to provide service access to the helm equipment. To open, slide the helm seat back to its furthest aft position, tilt the steering wheel to the full upright position, and unscrew the knurled knobs located on top of the helm and forward (toward the windshield). A strap holds the helm in the open position. To secure the helm back in place, close the helm and secure the knobs. The helm station must be secured before operating or transporting your boat, to prevent injury or damage. Do not open the helm station with engines running; accidental engagement of shift and throttle levers can occur.

WARNING

LOSS OF CONTROL AND UNSAFE BOAT HAZARD

Improper securing of the helm is hazardous and can cause death or serious injury from sudden loss of control. Make sure the helm is secure before getting underway and when transporting the boat.

CAUTION

Service or repairs to equipment inside your console should be performed by your Tiara Yachts dealer or other qualified marine repair technician. Failure to do so could result in damage to equipment used to safely operate the boat.

2.3 Engine Monitoring Displays

The helm is equipped with an engine-monitoring, multi-function display (MFD). The MFD allows the operator to monitor all engine functions, (including fuel level and motor trim) operate the engines most efficiently, and prevent serious, costly damage. The exact instrumentation is unique to the type of outboard engines installed on your boat. Refer to your engine package owner’s manual for information, features, and operation of this device.

2.4 Engine Throttle and Shift Controls

Depending on your boat’s engine package, starting the engines will require turning the key in the ignition and pressing the start button, or using an RFID key fob and ignition panel. Refer to your engine package owner’s manual for more information.

The specific shift and throttle controls installed on this Tiara Yacht will depend on your boat’s engine package. The following control description is typical to most outboard remote controls. Refer to your engine package owner’s manuals for specific information about the controls installed on your boat.

The helm is designed for a binnacle-style control with two throttle levers. Each throttle has a position for neutral (straight up and down), forward position (first detent forward of neutral) and reverse position (the first detent aft of neutral). Advancing the control lever beyond

the shift range will advance the throttle, forward or reverse. Refer to your engine package owner's manual for information about the operation of your specific engine package.

 CAUTION
<p>To avoid possible injury or engine damage when shifting:</p> <ul style="list-style-type: none"> • Pause in neutral before shifting from FORWARD to REVERSE, or REVERSE to NEUTRAL. • DO NOT shift into reverse while the traveling forward at speed. • Keep the area around the shifter control clear of obstructions.

If the starter engages with the shift controls in any position other than neutral, the neutral safety switch is not functioning properly and must be repaired before using your boat.

Control Systems Maintenance

Periodic inspection should be made of the control systems and all connections. Periodic lubrication of all moving parts and connections, using light waterproof grease, is required. Signs of rust, corrosion, wear, or other deterioration must be serviced immediately.

If control system adjustments become necessary, see your Tiara Yachts dealer.

2.5 Neutral Safety Switch

Every control has a neutral safety switch to prevent the engine from being started while in gear. Test the neutral safety switches periodically to ensure they are operating. To test the neutral safety switches, tilt the engines down and move the shift levers to the forward position, past first detent. **DO NOT** advance past the idle position. Attempt to start the engines following the directions in your engine owner's manual. The starter should not engage for any engine.

Repeat the test with the shift levers in reverse and the engine throttles at idle; the starter should not engage for any engine. If an engine starts in gear during this test, immediately move the control levers to the neutral position and turn the engine off. Ejection or sudden loss of control can occur if the neutral safety switch system does not function properly and an engine can start in gear.

 WARNING
<p>Test the neutral safety switch periodically. If the switch is not operating properly, DO NOT use the boat. Contact your Tiara Yachts dealer and have it repaired. A neutral safety switch not operating properly can allow the boat to start in FORWARD or REVERSE causing sudden boat movement and throwing operator and passengers.</p>

 WARNING
<p style="text-align: center;">LOSS OF CONTROL AND UNSAFE BOAT HAZARD</p> <p>A neutral safety switch that does not function properly can cause death or serious injury. DO NOT operate the boat if the switch does not function properly.</p>

2.6 Automatic Fire Suppression System

On generator-equipped boats, the Fireboy fire suppression system protects the generator compartment in case of fire. To manually discharge the fire suppression system, remove the pin and pull the red handle of the fire system manual discharge pull, located outboard of the helm seat.

The Fireboy panel, installed below the steering wheel, indicates if the system is charged or discharged. If the system is discharged, an audible alert will sound.



Fire system manual discharge pull



Fire suppression system status panel and override button

After the fire suppression system discharges, use the helm BLOWER switch to run the mechanical space blower for five minutes before opening the generator compartment. Reset the system using the override button on the status panel. Do not operate the boat until the fire suppression system has been recharged by your Tiara Yachts dealer or other qualified professional.

For additional important information, see section 9, Safety Information, and the automatic fire suppression system owner's manual.

2.7 Engine Stop Switch

Your Tiara Yacht is equipped with an engine stop switch and lanyard at the helm. When the lanyard is pulled away, it will shut off the engines.

Attach the engine stop switch lanyard to a strong piece of clothing on the operator. The

engines will not start if the clip is not inserted into the stop switch. Make sure the lanyard is properly attached to the engine stop switch before attempting to start the engine.



Engine stop switch and lanyard (typical)

! **WARNING**

LOSS OF CONTROL AND UNSAFE BOAT HAZARD

An engine stop switch system that does not function properly or is not used can cause death or serious injury. DO NOT operate the boat if the emergency stop switch system does not function properly.

DO NOT use the switch to stop the boat under normal operation. Test the switch periodically. If the switch is not operating properly, DO NOT use the boat. Contact your Tiara Yachts dealer and have it repaired.

Refer to the engine stop switch information in section 9, Safety Information, and the engine owner's manual for more information on the engine stop switch.

2.8 Engine Power Tilt and Trim

The outboard engines used on your boat have a tilt and trim feature. The tilt and trim switches are usually built into the engine shift and throttle controls, and allow the operator to control the position of the outboards from the helm. Moving the gear cases closer to the

boat transom is called trimming 'in' or 'down.' Moving the gear cases away from the boat transom is called trimming 'out' or 'up.' In most cases, the boat will perform best with the outboards adjusted so the hull will run at a three to five degree angle to the water.

The term 'trim' generally refers to the adjustment of the outboards within the first 20 degree range of travel. This is the range used while operating your boat on plane. The term 'tilt' refers to adjusting the outboards further up for shallow water operation, trailering, or 'tilting' the outboards out of the water. Refer to the engine owner's manual for information on the proper use and maintenance of the power tilt and trim.



CAUTION

The outboard hoses and cables and the transom gel coat can be damaged if the engine(s) are tilted to full up position or turned in the wrong direction. Turn the steering wheel completely to one direction or the other before tilting up to determine which direction is best for your boat.



WARNING

LOSS OF CONTROL AND UNSAFE BOAT HAZARD

Improper maintenance of the steering system is hazardous and can cause death or serious injury from sudden loss of control. Make sure all steering hardware, cables and fluid levels are regularly inspected and maintained. **DO NOT** attempt to service any part of the steering system unless you are qualified to do so. Follow all instructions regarding maintenance procedures in the steering system owner's manual.



Steering pump (typical)

2.9 Steering System

Your Tiara Yacht is equipped with either a steer-by-wire steering system or a combination steer-by-wire/hydraulic steering system. Refer to your steering system owner's manual for more information.

Steering System Maintenance

Periodically inspect all steering hoses, linkages, and helm assemblies. Signs of corrosion, cracking, loosening of fastenings, excessive wear, or deterioration must be corrected immediately. Periodic lubrication of all moving parts and connections with light waterproof grease is required. Failure to do so can lead to steering system failure and result in loss of control.

If your boat is equipped with a combination steer-by-wire/hydraulic steering system, check the hydraulic steering fluid level frequently and maintain the proper level. Hydraulic steering systems may need to be purged of air when first used or after repair. Refer to the steering system owner's manual for specifications and service information. Check steering operation and visually inspect for loose or missing hardware before operating the boat. If you suspect the steering system is damaged, see your Tiara Yachts dealer. **DO NOT** operate the boat if you suspect the steering system is malfunctioning.

2.10 Trim Tabs

Trim tab switches on the helm are used to control the trim tabs, which are installed on the transom of the hull. The switches are labeled and control bow up and down movements. They also control the starboard and port up and down movements. Bow up and bow down will control the hull planing attitude, while port and starboard up and down provide control for the hull trim side to side.

CAUTION

Before backing your boat at more than idle speed, depress both trim switches to UP to fully retract the trim tabs. Failure to do so could result in damage to trim tab actuators.



Trim tab switches

Before leaving the dock, make sure the tabs are in the full UP position by holding the trim tab switches in the BOW UP position for ten seconds. Do not continue to operate the switch once the tabs are fully up or down.

Establish the intended heading and cruise speed before attempting to adjust the hull attitude with the trim tabs. Always make slight adjustments to reduce over-correcting. After stabilizing speed and direction, move the trim tabs to achieve a level, side-to-side running attitude, being careful not to over-trim.

After depressing a trim tab switch, always wait a few seconds for the change in the trim

plane to take effect. Avoid depressing the switch while awaiting the trim plane reaction; otherwise, by the time the effect is noticeable, the trim tab plane will have moved too far and the boat will be in an overcompensated position.

When running at a speed that will result in the boat falling off plane, lower the tabs slightly, bow down, to improve the running angle and operating efficiency. Lowering tabs too far can reduce operating efficiency and cause difficult steering and handling.

When running at high speeds, make sure the tabs are in the full UP position. Use only the necessary trim plane action to compensate for any listing. Trim tabs are more sensitive at higher speeds. Adjust for this and be prepared to slow down if difficulties arise.

Be extremely careful when operating in a following sea. The effect of trim tabs is amplified under these conditions. Difficulty in steering and handling can result from improper trim tab usage, especially in a following sea; using the switches, raise the tabs to the full bow UP position.

When running into a chop, a slight bow-down attitude will improve the ride. Be careful not to over trim; difficulty in handling can result.

Trim Tab Indicator

The trim tab switches are labeled to indicate the reaction of the bow of the boat. The L.E.D. lights indicate the position of the trim tabs. When adjusting the starboard bow up or down, the L.E.D. lights on the right side of the panel will activate, indicating the movement of the port tab. Refer to the trim tab operation manual.

Trim Tab Maintenance

Marine growth can affect the operation of the trim tab planes and actuators. To help reduce marine growth, return the trim tabs to the full UP position after operating the boat. Inspect and clean the actuators and planes regularly.

The trim tabs also include a zinc anode to help prevent galvanic corrosion. Galvanic corrosion occurs when different metals are submerged in an electrolyte. Sea water is an electrolyte and submerged metal components must be protected. Anodes were factory installed and need to be replaced when they are 75% of their original size.

Refer to the sacrificial anodes information in section 11, Routine Maintenance, and the trim tab owner's manual for additional maintenance information and fluid specifications.

2.11 Compass

The compass is located at the helm. To adjust the compass, read the instructions on 'Compass Compensation' provided with this manual. The compass cannot be adjusted accurately at the factory; it must be compensated for the influence of the electrical equipment and electronics unique to your boat. The compass should be adjusted by a professional after all electronics and additional electrical accessories are installed and before operating the boat.

2.12 Bow Thruster

The bow thruster is electrically driven and controlled by a joystick on the helm.



Bow thruster control

Operate in short bursts of a few seconds to preserve battery life. Refer to the bow thruster owner's manual for more operation and maintenance information.

For service access to the bow thruster motor, remove the aft-facing panel on the forward interior bulkhead of the ski locker.

The bow thruster battery switch is mounted on side of the Master DC Panel box, located in the mechanical space.



Bow thruster battery switch



CAUTION

Do not operate the bow thruster out of the water, even momentarily. Water must be supplied to prevent the impeller from over-speeding, which will result in serious damage and void the warranty.



WARNING

ROTATING PARTS HAZARD

A rotating bow thruster can cut, entangle or draw a swimmer closer or into the thruster, causing death or serious injury. DO NOT use the bow thruster near swimmers.

2.13 Joystick

The optional joystick control, if installed, may be used in place of the steering wheel and shift/throttle levers to control the boat at low speed or during docking maneuvers. With its intuitive operation, the joystick allows the operator to move the boat at various slow speeds in any direction, spin the boat on its

own axis, and move the vessel sideways. See your engine package owner's manual for more information.

2.14 Spotlight (optional)

Operate the optional ACR spotlight using the control panel mounted on the helm below the steering wheel. Refer to the spotlight owner's manual for operating instructions.



Spotlight control

Fuel Systems

3.1 General

The fuel system of your boat is designed to meet the requirements of the U.S. Coast Guard, Environmental Protection Agency (EPA), National Marine Manufacturers Association (NMMA), and American Boat and Yacht Council (ABYC) in effect at the time of manufacture.

DANGER

FIRE/EXPLOSION HAZARD

Fuel and its vapors are highly explosive when exposed to open flame or spark, resulting in death or serious injury.

- **Make sure no vapors are present before turning on electrical equipment or starting engines.**
- **Make sure fuel is added to the fuel tank only. DO NOT confuse other deck fills with fuel fills.**
- **DO NOT remove anti-siphon valves from the system.**
- **Turn off all electrical switches before servicing the fuel system.**
- **DO NOT drain any fuel into the bilge.**
- **Check all fuel lines and fittings for leaks before and after starting the engines and after any fuel system service.**
- **Prime the fuel system and check all fittings for leaks before and after starting the engines.**
- **DO NOT block fuel vents.**
- **DO NOT store fuel in any containers or compartments not designated for fuel storage.**

Tiara has engineered an improved, EPA-compliant fuel tank fill and vent system. The system reduces or eliminates fuel spillage when using a standard automatic shut-off fuel fill nozzle at marinas and gas stations. While

this system provides a clean, consistent refueling experience, it still requires the operator’s attention and must not be defeated by attempts to over-fill the tank with fuel. This system will automatically provide the proper air space (approximately 5% of total tank volume) in the fuel tank to accommodate the expansion of fuel during daily temperature cycles.

The fuel cap has been updated to help the operator verify the cap is properly closed. This fuel system is engineered to vent through a carbon canister when the fuel cap is installed. This will greatly reduce fuel vapors that escape into the atmosphere and reduce the fuel odor that can be present with traditional systems.

The fuel system was factory-inspected and pressure-tested in accordance with regulations in effect at the time of manufacture. It is the responsibility of the boat owner to maintain the safe condition of the system. Inspect the system frequently to ensure no deterioration or loosening of connections has occurred.

NOTICE

Certain bulkhead areas are sealed in compliance with U.S. Coast Guard regulations at the date of manufacture. Any modifications must be made in accordance with the regulations.

3.2 Fuel System

WARNING

Failure to follow proper fuel system priming procedures will result in damage to fuel management system. The fuel system should be serviced by qualified personnel only. In the event of absolute fuel depletion to the engines, contact a certified Mercury Marine technician.

The outboard engines draw fuel from a single fuel tank. Both fuel fills, on the port and starboard gunwale, may be used to fill the tank.

All boats equipped with gasoline engines are required by the U.S. Coast Guard to have anti-siphon valves. The fuel delivery lines are equipped with anti-siphon valves where the lines attach to the fuel tank. These valves help prevent gasoline from siphoning out of the fuel tank should a line rupture.

DO NOT remove the anti-siphon valves from the system. Anti-siphon valves prevent fuel from flowing into the bilge should a fuel hose or fitting leak. If the valve becomes clogged, clean and reinstall or replace it.

Fuel Tank

The fuel tank holds approximately 330 gallons (1,253 liters) of fuel. Fuel pick-up tubes are positioned in the tank to achieve optimum fuel usage, fuel line routing, etc. At certain speeds and hull trim angles, the fuel supply at the withdrawal tube can increase or decrease accordingly. Be extremely careful when attempting to operate the boat when low on fuel. Though some fuel may be in the tank, the trim angle of the boat may cause the fuel to flow away from the pickup tubes.

Fuel Gauge Senders

The fuel gauge senders are more accurate when the boat is stationary and level. Because of the change in attitude when the boat is underway, variations in gauge readings can occur. This system is a relative indication of the available fuel supply and not a calibrated instrument.

Fuel Fills

Gasoline fuel fills are located on each gunwale and are marked with a gasoline pump icon. Both the starboard and port fuel fills feed the boat's single tank.



Gasoline fuel fill



WARNING

Fuel is flammable. Do not smoke. Never fill the tank while the engines, blowers, generator, or other equipment is operating. Do not fill near open flames.

Fueling Instructions

1. Turn off all breakers on the AC and DC distribution panels, located in the head compartment electrical cabinet.
2. Make sure the generator is OFF.
3. Make sure your boat is securely moored.
4. Close all port lights, hatches, and doors.
5. Estimate how much fuel will be needed to fill the tank.



DANGER

FIRE/EXPLOSION HAZARD

Gasoline vapors are highly explosive when exposed to open flame or spark, resulting in death or serious injury.

- **Stop engines before fueling.**
- **DO NOT smoke or allow open flames or sparks nearby, within 50 ft (15 m) of the fueling area.**
- **Maintain contact between fuel nozzle and fuel tank fill to prevent electrostatic spark. DO NOT use a plastic funnel.**
- **Fill in an open area.**

 **DANGER**

BURN HAZARD
Ignited fuel floating on water can cause death or serious injury. Fuel will float on top of water and can burn. If the boat is abandoned, swim upwind, far enough to avoid fuel that can spread over the surface of the water.

 **WARNING**

Be sure that the fuel fill is in contact with the fuel nozzle to prevent any static sparks during the fueling operation. Failure to heed this warning could result in a static electricity charge that could lead to injury, damage, or death.

6. Open the fuel fill by turning it counter-clockwise.
7. Insert the fuel nozzle into the fuel fill and dispense the fuel until the tank is full. Verify that the tank is full by reading the fuel gauge and/or by the sound of the fuel fill filling up. If your tank takes significantly more fuel than expected, investigate the cause immediately.
8. After fueling, screw the cap on in a clockwise direction until an audible click is heard, indicating that the cap is seated. If the cap is lost or damaged, replace only with original equipment; contact Tiara Yachts Customer Relations or your Tiara Yachts dealer.
9. Wash the areas around the fuel fill(s) to help reduce discoloration of the fiberglass or striping. Use only the fuel recommended by the engine manufacturer. Refer to the engine owner’s manual for additional information.
10. Check the mechanical space and bilge areas for fuel odors. If you smell fuel, do not start the engines or other electrical equipment. Investigate and correct the problem, and completely ventilate the bilge area before proceeding.

During refueling, the tank will vent out at both the fuel fill plate and the vent located on the side of the hull. **Note:** There should not be any residual fuel at the vent but there could be residual fuel at the deck fill plate. Do not block or restrict either of these vents.

If fuel is accidentally added to any other tank, DO NOT attempt to pump the fuel out; these systems are not designed to pump fuel. Fuel must be removed by qualified personnel only. Fuel in other systems will also require replacement of that system and/or multiple components.

Try not to spill fuel. If fuel is spilled, wipe up all traces with dry rags and immediately dispose of the rags properly onshore. DO NOT allow fuel to stay on the finish of the boat, as discoloration and damage to trim can occur. Avoid fueling at night, except under well-lighted conditions. Also, monitor the fuel level to avoid overfilling.

 **WARNING**

The Federal Water Pollution Control Act prohibits the discharge of oil or oily waste into or upon the navigable waters of the United States, or the waters of the Contiguous Zone, or which may affect natural resources belonging to, appertaining to, or under the exclusive management authority of the United States, if such discharge causes a film or discoloration of the surface of the water or causes a sludge or emulsion beneath the surface of the water. Violators are subject to substantial civil penalties and/or criminal sanctions, including fines and imprisonment. Report all discharges to the USCG National Response Center at 1-800-424-8802 or to your local U.S. Coast Guard office by phone or VHF radio, Channel 16.

**WARNING**

Do not start the engines until you are sure there are no fuel fumes in the bilge or engine compartment of your boat. Fuel vapors are explosive and may ignite during engine start-up, causing serious injury or death.

**CAUTION**

To reduce the risk of fire, investigate all fuel odors immediately and do not start the engines, generator or other electrical equipment if fuel odors are present.

**CAUTION**

A no-spill vent system is used so that fuel will not spill out of the vents when filling; however, fuel will exit the fuel fill pipe if overfilling occurs. When filling the fuel tank listen carefully for fuel filling up in the fill pipe.

**NOTICE**

To prevent damage to your fuel system, use only a quality grade of fuel as recommended by the engine manufacturer. Do not use a fuel which contains harsh additives. Damage to your fuel system as a result of using these fuels will not be covered by your warranty.

**NOTICE**

Be careful not to spill any fuel outside the boat into the water. If you do, clean up the fuel immediately in the manner prescribed by your local regulations.

Fuel Water Separating Filters

Fuel filters are located along the forward bulkhead of the mechanical space. There is one water-separator type filter for each engine fuel line. Check all filters for water frequently to ensure an adequate supply of clean, dry fuel to the engines. The filter elements should be changed every 500 engine hours, at every other oil change, once a season, or if a power loss is noticed, whichever comes first.

Turn off all electrical switches before servicing the fuel system and DO NOT drain any fuel into the bilge. Prime the fuel system and check all fuel lines and fittings for leaks before and after starting the engines, and after any fuel system service. See the end of this section for more fuel system maintenance information.



Gasoline fuel water separating filters (typical)

3.3 Diesel Generator Fuel System

The generator and 30-gallon diesel generator fuel tank are located in the mechanical space. The generator tank is filled through a deck fill marked DIESEL on the starboard gunwale.

Check the diesel fuel level using the gauge on the engine multi-function display at the helm, or the control panel on the generator. The fuel level may be read without starting the generator.

The diesel fuel system works much like the gas system. However, the diesel system isn't equipped with anti-siphon valves, and there is a fuel return line to return unused fuel to the fuel tank. The diesel system may require priming after servicing. Refer to the generator owner's manual for more information.

Make sure the fuel valve on top of the diesel tank is in the ON position before attempting to start the generator. The diesel tank is installed in the aft mechanical space.

The generator water-separator fuel filter is installed on the starboard side of the mechanical space. The fuel filter has a sediment bowl that must be inspected for water frequently to ensure an adequate supply of clean, water-free fuel is supplied to the engine. Inspect the filter periodically and change the element as needed.



Diesel fuel fill

! **CAUTION**

DO NOT confuse the diesel and gas fuel fills; severe engine damage will result.

Diesel Generator Fueling Instructions

Try not to spill fuel. If fuel is spilled, wipe up all traces with dry rags and immediately dispose of the rags properly onshore. DO NOT allow fuel to stay on the finish of the boat, as discoloration and damage to trim can occur.

Avoid fueling at night, except under well-lighted conditions. Also, monitor the fuel level to avoid overfilling.

To fill the generator diesel fuel tank:

1. Turn off all breakers on the AC and DC distribution panels, located in the head compartment electrical cabinet.
2. Secure boat and remove all passengers.
3. Extinguish all flame-producing items.
4. Confirm the use of the correct fuel fill (gas vs diesel).
5. Open fuel fill by turning counterclockwise.
6. Put nozzle in the fuel fill opening.
7. The fuel delivery system will shut off when the tank is filled to the proper capacity.
8. Remove the nozzle. Install the fuel fill cap and turn clockwise, tightening until it clicks.
9. Check the fuel compartment and below the deck for fuel odors. If you smell fuel, DO NOT start the engines.



Generator water-separator fuel filter (typical)

**DANGER****FIRE/EXPLOSION HAZARD**

Gasoline vapors are highly explosive when exposed to open flame or spark, resulting in death or serious injury.

- Stop engines before fueling.
- DO NOT smoke or allow open flames or sparks nearby, within 50 ft (15 m) of the fueling area.
- Maintain contact between fuel nozzle and fuel tank fill to prevent electrostatic spark. DO NOT use a plastic funnel.
- Fill in an open area.

**DANGER****BURN HAZARD**

Fuel floating on water which is ignited can cause death or serious injury. Fuel will float on top of water and can burn. If the boat is abandoned, swim upwind, far enough to avoid fuel that can spread over the surface of the water.

**CAUTION**

Use only the fuel recommended by the engine manufacturer. The use of old, contaminated fuel can cause severe damage or engine malfunction. Do not use fuel that contains more than 10% ethanol, harsh additives or methanol; damage to the engines and fuel system will result. Fuel system damage, related to use of alcohol-blended fuels, is not covered by the Tiara Limited Warranty. Refer to the engine owner's manual for specific fuel requirements for your engines.

**DANGER****FIRE / EXPLOSION HAZARD**

Fuels are extremely flammable and highly explosive under certain conditions. DO NOT smoke or allow open flames or sparks nearby when inspecting the fuel system. Check fuel lines and all system components (filters, primer bulbs, clamps and connections) frequently for leaks, damage or deterioration. If you suspect damage, replace as necessary. Surface cracking on a hose indicates wear—replace it.

3.4 Fuel System Maintenance

Spray the valves, fuel tank gauge sender and ground connections with a metal protector.

Inspect the fuel fill cap o-ring seals frequently and lubricate with petroleum jelly or silicone grease. The o-ring seal prevents water from entering the fuel system through the fuel fill cap. If the o-ring is damaged, or you suspect it is damaged, replace it.

Old, degraded gasoline can affect engine performance and damage the engine and boat fuel system. Chemical changes occur as gasoline ages, reducing octane and causing deposits and varnish in the fuel system.

If your boat is not operated enough to require at least one full tank of fresh fuel a month, a fuel stabilizer should be added to the gasoline to protect the fuel from degrading. Do not allow the boat to sit unused for an extended period with the fuel tank less than 3/4 full. Changes in temperature and weather conditions can cause condensation in fuel tank. Your Tiara Yachts dealer or the engine manufacturer can provide additional information on fuel degrading and fuel stabilizers recommended for your engine.

Improper storage of fuel at marinas, limited boat usage, etc., can cause fuel to become contaminated. Periodically, it may be necessary to pump accumulating water and contaminated fuel from the bottom of the fuel tank. If the fuel system on your boat becomes contaminated, contact your dealer or marina for assistance.

Properly dispose of any oil contaminated rags per the local environmental requirements.

Avoid using fuels with alcohol additives. Alcohol blend gasoline will absorb moisture from the air which can reach such concentrations that 'phase separation' can occur where the water and alcohol mixture becomes heavy enough to settle out of the gasoline to the bottom of the tank. Since the fuel pickup tubes are near the bottom of the tank, phase separation can cause the engine to run very poorly or not at all. Phase separation is more severe with methyl alcohol and will increase as the alcohol content increases. Water or a jelly-like substance in the fuel filters is an indication of phase separation from the use of alcohol-blended fuels.

Diesel engine operation requires a good supply of clean, water-free diesel fuel. Algae can grow in the accumulated water in the diesel fuel tank. This will normally occur in warm climates. Adding a high-quality diesel fuel additive containing an algaecide may be required periodically to control algae in your diesel system, depending on your boating area. Contact your Tiara Yachts dealer or engine manufacturer for additional information regarding fuels and additives.

3.5 Oil Change System (optional)

If equipped, an oil change system for the generator is installed in the mechanical space. Please read the instructions provided from the system manufacturer for operation.

Note: Be certain to clean up any oil spilled in the bilge during oil changing operations. Failure to do so can allow the bilge pumps to transfer the oil into the surrounding water.

Electrical Systems

4.1 General

The electrical systems in your Tiara Yacht have been developed to supply all the boat’s electrical needs at the dock, at anchor, and underway. While this manual will not attempt to describe all of the electrical engineering that went into the system, a basic understanding will help assure trouble-free operation.

Your boat is equipped with DC and AC electrical systems. The DC system draws current from onboard batteries. The AC system can draw current from either dockside (shore power) outlets or the generator.

Electrical schematics are included in Appendix F to assist technicians in the servicing of the electrical systems. Tiara recommends you take your boat to an authorized Tiara Yachts dealer for service or installation of additional electrical equipment. Tiara reserves the right to modify or update the electrical system at any time without notice to the consumer or obligation to make updates to boats built prior to the change.

! WARNING

All electric system service work should be performed only by an authorized Tiara Yachts dealer or other qualified marine electrical service facility. Failure to heed this warning may result in personal injury or death.

4.2 12-Volt DC System

Power Supply

Six 12-volt batteries have been selected to provide optimum performance for engine starting and house loads. Boats equipped with an optional gyro are outfitted with two additional batteries. The batteries are located

in the mechanical space. Refer to the engine owner’s manual for information about the circuit breakers installed on your engines.

The house battery bank supplies power to all the boat’s comfort and convenience functions such as lighting, pumps, actuators, stereo, and electronics, as well as the bow thruster. The house bank should also be used to power any aftermarket electronics.

! CAUTION

All aftermarket electrical components should be installed by your Tiara Yachts dealer or other qualified marine electrical service facility. They must be installed to be powered from the house battery bank only. The engine battery banks are strictly reserved for engine power only.

Battery Charging

The 12-volt DC system batteries are charged by the engine charging system or by the battery charger when connected to shore power or operating the generator.



Battery chargers (typical)

Your boat is equipped with two battery chargers. The 40 amp charger (60 amp if the boat is equipped with an optional gyro) charges the house batteries, and the 20 amp charger charges the engine batteries. Both chargers are calibrated to provide the proper charge levels for each specific battery. Changing the battery specification will require recalibration

of the battery chargers. The battery chargers are located in the mechanical space.

It is important that your batteries be kept in a state of full charge as much as possible. Fully charged 12V batteries will indicate a voltage in excess of 12.6 volts with no load, or while being charged. Consult the DC voltmeter on the DC distribution panel (in the head compartment electrical cabinet) or the helm MFD to check battery voltage.

Prolonged periods of discharge will cause the batteries to deteriorate rapidly, and will result in their inability to hold a charge for the expected amount of time. This can happen easily if excessive DC loads (such as lights) are left on while the battery charger is off.

At dockside, when the boat is connected to shore power, the battery chargers maintain the charge on the engine and house batteries. When operating the generator, the engine and house battery chargers must be on to maintain charge to the batteries.

Leave your boat connected to shore power with the battery chargers ON when leaving for any extended period of time. To do so, be sure the BATTERY CHARGER switches on both the Master DC Panel (in the mechanical space) and the AC distribution panel (in the head compartment electrical cabinet) are ON.

Automatic Charging Relay (ACR)

Your Tiara Yacht is equipped with an automatic charging relay (ACR). The ACR box is installed inside the Master DC Panel in the mechanical space.

The ACR automatically parallels (combines) battery banks during charging, and isolates them when charging has stopped and battery voltage has fallen. The ACR allows temporary isolation of house loads from the engine circuit during engine cranking, in order to protect sensitive electronics. It is intended to keep a load from discharging both of the battery banks. The LED light on the ACR box indi-

cates when batteries are combined. See the automatic charging relay owner's manual for more information.



Automatic Charging Relay box (typical)

DC Distribution

Power from each engine battery supplies the respective red engine battery switch (STBD, CENTER, PORT) on the Master DC Panel, located in the mechanical space. A circuit breaker on each engine protects the engine ignition systems and gauges. Refer to the engine owner's manual for information about your engines. The red main engine battery switches may be controlled remotely by the PORT BATTERY, CENTER BATTERY (if installed), and STBD BATTERY buttons on the DC distribution panel, located in the head compartment electrical cabinet.

Power from the house batteries supplies the red HOUSE battery switch, which may be controlled remotely by the HOUSE BATTERY button on the DC distribution panel. Battery switches and breakers on the DC distribution panel protect the switch panels on the helm.

When the red main battery switches on the Master DC Panel are in the OFF position, all DC power to the rest of the boat (including the high water alarm) is disconnected. **The only exceptions** are the forward, mid, and aft automatic bilge pumps and the shower sump box. Shutting OFF the red main battery switches will not disconnect power to bilge pumps.

4.3 Master DC Panel Breakers

The breakers on the Master DC Panel provide circuit protection for some of the following components (your boat's panel may vary). The breaker must be switched ON for its corresponding component to operate.

Bilge Fwd: The forward bilge pump, located under the forward ski locker floor hatch.

Bilge Mid: The mid bilge pump, located in the forward mechanical space.

Bilge Aft: The aft bilge pump, located in the aft mechanical space.

Shower Sump: The shower sump pump, installed under the aft hatch in the centerline ski locker.

Battery Chargers: The house and engine battery chargers.

Underwater Lights: The underwater lights. Use these lights only when the boat is in the water since they rely on water for cooling.

Spotlight (optional): The spotlight, if installed.

Engine Control: The individual engine alternators that charge the house batteries. These switches should remain ON.

Cabin Main: The DC distribution panel, installed in the head compartment electrical cabinet.

Windlass: The windlass. Turn the breaker OFF when the windlass is not in use to reduce the possibility of accidental activation.

Eng Room Fans: The exhaust blower in the mechanical space.

Gyro Stabilizer (optional): The Seakeeper gyro stabilizer, if installed.

Gyro Pump: The gyro water pump, if the gyro is installed.

Oil Change Pump (optional): The generator oil change pump, if installed

Eng Room Lights: The mechanical space lights.



Master DC Panel

4.4 12-Volt DC Helm Switches

There are a number of switches on the helm. For any of the switches to function, the corresponding circuit breaker on the DC distribution panel, located in the head compartment electrical cabinet, must be switched ON.

Horn: Activates the boat horn.

Underwater Lights: Activates the underwater lights. Use these lights only when the boat is in the water since they rely on water for cooling.

Hardtop Wht Lts: Activates the white lights mounted underneath the hardtop

Hardtop Red Lts: Activates the red lights mounted underneath the hardtop. For use when navigating at night.

Washer: Activates the windshield washer. The WATER PUMP breaker on the DC distribution panel must be ON.

Wiper On/Off: Activates the windshield wiper.

Wiper Hi/Lo: Selects high (fast) or low (slow) windshield wiper speed.

Seat Aft/Fwd: Moves the helm seat forward or aft.

Sunshade Open/Close: Opens or closes the aft cockpit sunshade, if installed.

Windlass Deploy/Retrieve: Deploys and retrieves the anchor. Refer to the windlass information in section 7, Exterior Equipment.

Nav Lights: Activates the red and green navigation (or 'running') lights and the all-around light on the masthead. Use when operating the boat at night or when visibility is reduced.

CAUTION

Always make sure the aft navigation light is visible. Never obstruct or block the visibility of any of the navigation (NAV) lights.

Anc Light: Activates the all-around anchor light on the masthead. Use this light when the boat is at anchor at night.

Aft Bilge, Mid Bilge, and Fwd Bilge: Activates the respective aft, mid, and forward bilge pumps. If the pump activates automatically, the bilge pump button will light up.

Tow (optional): Activates only the aft-facing light on the mast. Use this light only when the boat is being towed by another vessel.

Blower: Activates the mechanical space exhaust blower.

ACC: Unassigned and reserved for user-installed accessories. DO NOT install a component with an operating current that exceeds 10 amps (12V DC).

4.5 DC Distribution Panel

DC Volt Meter

Periodically monitor the voltage (charge) on your batteries. To do so, use the METER SELECT switch on the DC distribution panel to determine which battery to monitor. The voltage for the selected battery will register

on the volt meter. Do not operate the DC system if the voltage is lower than 105v or higher than 130v.

DC Breakers

The breakers on the DC distribution panel, located in the head compartment electrical cabinet, must be switched ON for the corresponding components to function.



DC distribution panel

Stereo: Supplies power to the stereo, amplifier, and the stereo remote unit(s).

Thruster: Supplies power to the bow thruster.

Horn: Supplies power to the horn, installed at the helm.

Trim Tabs: Supplies power to the trim tabs.

Cabin Lights: Supplies power to cabin light switches.

Courtesy Lights: Supplies power to switches that control the hardtop flood lights.

Nav/Anc Lights: Supplies power to the NAV and ANC LIGHTS helm buttons.

Sun Shade: Supplies power to the SUNSHADE helm button.

Helm B: Supplies power to the WIPER, SEAT, WINDLASS, and WASHER helm buttons.

Vacuum Pump: Provides power to the head vacuum flush pump. Must be switched ON in order for the head vacuum flush to function.

Waste Pumpout (optional): Supplies power to the overboard waste discharge pump, if installed. This breaker should be kept OFF at all times unless pumping waste overboard in a legal raw sewage discharge area. See section 5, Plumbing Systems, for more information.

Electronics: Supplies power to the electronics at the helm.

Refrigerator: Supplies power to the mid-cockpit refrigerator(s).

Fresh Water Pump: Supplies power to the fresh water pump. Must be turned ON in order to use the shower, sinks, head, windshield washer, and other freshwater system components. Turn OFF when the boat is unattended.

Washdown Pump (optional): Supplies power to the pressure-demand raw water washdown pump, if installed. The pump is also protected by an automatically resetting breaker on the pump motor. Refer to section 5, Plumbing Systems, for more information.

4.6 Seakeeper Gyro (optional)

If your boat is equipped with the optional Seakeeper® gyro, be sure to become familiar with the gyro low voltage alarm. Refer to the Seakeeper owners manual for additional information.

In situations where there is a net discharge on the house battery bank (i.e. engines off), the Seakeeper – which continually monitors battery voltage – will run at full power until it detects 11.1 VDC at the gyro. At this level, which reflects approximately 11.3-11.5 VDC at the battery bank, the Seakeeper will begin incrementally decreasing its power consumption to ensure that its measured voltage does not decrease below 11.0 VDC.

During this decrease in power consumption, if the measured voltage at the gyro does not increase above 11.1 VDC, then the Seakeeper will continue to de-rate power consumption until it reaches 67% of its flywheel target speed. At this point, an alarm will trigger and the Seakeeper will shut itself down.

Seakeeper Display Low Voltage Alarm

If, before the 67% flywheel speed automatic shutdown is triggered, a net charge is fed back into the battery bank (i.e. engines have been started) and the voltage at the Seakeeper is raised above 11.1 VDC, the Seakeeper will detect this and begin incrementally increasing its power consumption once again, until it resumes full-speed stabilization.

If the system voltage is raised after the 67% flywheel speed automatic shutdown is triggered, the user will need to manually restart the Seakeeper to resume stabilization.

4.7 AC System

Either shore power or generator power may be used to supply AC current to the AC distribution panel, located in the head compartment electrical cabinet. All AC current is distributed to AC components through individual 120V (230V for CE) circuit breakers located on the AC distribution panel.



Shore power and generator select switches and polarity indicator lights

The AC electrical system operates on a 120 volt, 30 amp, 60 Hz system. The AC system is fed by shore power or by the generator. An isolation transformer maintains correct AC polarity regardless of the polarity of the shore

power supply, and eliminates the need for a galvanic isolation system and reverse polarity indicator. Refer to the isolation transformer manual for additional information.

The power selector breakers in the AC distribution panel are equipped with a selector slide to prevent the shore power source and the generator source from being energized simultaneously and damaging the electrical system components. Refer to further information about shore and generator power later in this section.

DANGER

ELECTROCUTION, FIRE OR EXPLOSION HAZARD

Contact with live wires or working on an energized electrical system can cause electrocution. It can also cause sparks, resulting in fire and/or explosion. Both cases will result in death or serious injury. DO NOT work on an energized system or allow unqualified personnel to work on the system.

4.8 AC Distribution Panel

The AC distribution panel is located in the head compartment electrical cabinet.

AC Voltmeter

Monitor the available AC voltage periodically, in order to detect abnormal operating conditions early. To check the voltage, consult the voltmeter on the AC distribution panel or the helm multi-function display (MFD). The voltmeter will indicate the current voltage of the power source (shore power or generator) and the load currently being applied to that source. If the voltage being supplied while using the 120V-30A connection is lower than 105V or higher than 130V, discontinue use and correct the problem as soon as possible.

AC Main Breakers

The shore power (BUS A and BUS B SHORE) and generator (BUS A and BUS B GEN) main breakers protect the AC distribution system. These breakers are very sensitive. The resulting power surge that occurs when connecting the dockside cord or starting the generator may cause the main breaker to trip. To avoid this surge, always turn the breakers to the OFF position before plugging or unplugging the shore power cord or starting or stopping the generator.



AC distribution panel

There are a number of breakers on the AC distribution panel, which need to be switched ON for their corresponding components to operate:

Air Cond Pump: Supplies electrical current to the air conditioner pump. This breaker must be ON in order to use the air conditioning unit(s).

Air Cond 1, 2, and 3 breakers: Air conditioning units. The AIR COND PUMP breaker must be turned ON to operate the air conditioning. See section 6, Ventilation Systems, for climate control panel locations. Refer to the air conditioner user manual for additional information.

Outlets: Supply electrical current to the boat's electrical outlets and protect against short circuits and overloads. AC electrical outlets are provided with ground fault interrupt-

ers (GFI) to protect against electric shock. To ensure proper operation, these outlets should be tested periodically by pressing the test/reset buttons in the center of the face plate. The GFI outlets themselves do not protect against short circuits and overloads. **NOTE:** GFI outlets do not provide 100% protection from electric shock. Even though ground fault interrupters provide protection by reducing exposure time from line to ground shock hazards, it is still possible to receive an electric shock from defective appliances or power tools and misused electrical equipment.

Cockpit Refrig: Supplies electrical current to the mid-cockpit galley refrigerator(s).

Deck Grill: Supplies electrical current to the mid-cockpit galley grill. This breaker should ONLY be on when the grill is being used. See the grill owner’s manual for more information.

Ice Maker (optional): Supplies electrical current to the cockpit ice maker, if installed.

Battery Charger: These switches supply power to the battery chargers, which maintain the charge on the engine and house batteries. These breakers should ALWAYS be ON when shore power is connected or the generator is operating. The battery chargers, located in the mechanical space, are equipped with an ammeter to monitor charging. See the battery charger owner’s manual for more information.

Water Heater: Supplies electrical current to the water heater. The water temperature is automatically controlled by the temperature valve on the water heater. Do NOT turn this breaker ON without having water in the water heater. See section 5, Plumbing Systems, and the water heater owner’s manual for more information.

4.9 Other Electrical Controls

The head compartment electrical cabinet houses the bilge alert high water alarm and power/test button; remote generator control

panel; climate control panel; waste holding tank and water tank monitor; and the AC and DC distribution panels.



Water alarm; generator control panel; climate control panel; and waste/water tank level indicators

4.10 Shore Power Connection

The shore power system is designed to be connected to one or two 120V/30A dockside outlets. Before every use, check the shore power cord(s) for cracks and chafing of the insulation, and check cord terminals for corrosion or heat damage.



Main shorepower inlets in the port aft lounge seat base

1. Turn OFF the main shore power breaker(s) on the AC distribution panel, and the breaker(s) in the port aft lounge seat base, accessible by lifting the seat cushion. If dockside outlet(s) include a disconnect switch(es) or circuit breaker(s), turn it OFF.
2. Locate the shore power inlets, installed on the port transom. Unscrew the shore

inlet cover and plug the cord in. To avoid strain on the cable, make sure it has more slack than the mooring lines. Position the cable so that it cannot be damaged by chafing between the boat and the dock. Make sure the cable does not come in contact with the water.



Shore power and cable TV inlets

3. Connect the cable to the dockside outlet. Tighten the lock rings on both the shore and the boat connector plugs.
4. Turn the dockside disconnect switch(es) or circuit breaker(s) to the ON position.
5. Turn on the shore power breaker(s) in the port aft lounge seat base.



Shore power and generator indicator lights, on the AC distribution panel (typical)

6. Check the shore power indicator lights on the AC distribution panel. **Note:** If the red light is illuminated, do not proceed. Turn OFF all breakers and contact marina personnel immediately.
7. Switch ON the BUS A and BUS B SHORE breakers on the AC distribution panel.



DANGER

ELECTROCUTION HAZARD

Exposure to high voltage will cause death or serious injury. **DO NOT** attempt to correct wiring yourself. **DO NOT** swim in marinas or near boats connected to shore power. Keep children away from any electrical cables or equipment and use grounded appliances onboard only.



WARNING

Do not make connections in wet weather, with wet hands, or with wet cables and connections. Always use a 3-wire electrical system connected to a ground. Do not use worn or damaged cables. Failure to heed this warning can result in an electrical shock injury or death.



CAUTION

When routing electric cables and dockside water hoses to the dock, be sure to allow sufficient slack so the cables and hoses will not be strained in any way as the boat moves within its slip. Do not allow cables or hoses to dangle into the water.

Disconnecting from Shore Power

Turn OFF the BUS A and BUS B SHORE breakers on the AC distribution panel and in the aft cockpit shore power cabinet. If the dockside outlet(s) includes a disconnect switch(es) or circuit breaker(s), turn them to the OFF position. Disconnect the cable from the dockside outlet(s) and replace the outlet caps. Return the cable to the boat.

4.11 Generator

The diesel generator is located in an enclosure in the mechanical space. Fuel-injected generators require bleeding of air from the fuel delivery system prior to initial start-up. Bleeding of the fuel system will also be required if the generator is allowed to run out of fuel. Continued attempts to start the generator without bleeding the fuel system under these circumstances can lead to engine damage or erratic operation. This procedure must be completed by your servicing dealer.



Remote generator control panel, in the head compartment electrical cabinet

The generator is equipped with an automated start-up sequence to prevent over-cranking (which can lead to engine damage) and to ensure that the generator is up to operating temperature before the electrical load is applied. The display on the remote generator control panel, in the head compartment electrical cabinet, provides detailed information on the operating status of the generator.

Refer to the generator owner's manual for instructions on operation and interpretation of the displayed data.

Activate the house battery charger to maintain the house batteries whenever the generator is running. Because of the number of DC systems on this boat, a significant drain on the batteries can occur. Depending on the RPM and the duration of operation of the engines, the engines' charging systems may not be able to keep up with the DC electrical demand, particularly when the engines are run at low RPM for extended periods. To ensure that the batteries remain at peak charge, Tiara strongly recommends that the generator be run whenever the boat is in use (and not connected to shore power).

WARNING

Do not start the generator until you are sure there are no fuel fumes in the bilge or mechanical space. Fuel vapors are explosive and may ignite during generator start-up, causing serious injury or death.

CAUTION

To reduce the risk of fire, investigate all fuel odors immediately and do not start the engines, generator, or other electrical equipment if fuel odors are present.

CAUTION

Before starting the generator, ensure the fuel supply and return valves are open. A fuel valve is open when it is parallel to its associated fitting. Failure to open all fuel valves will damage the generator.

**CAUTION**

DO NOT start the generator with the AC distribution panel power selector switch in the GENERATOR position. Allow the generator to warm-up three to four minutes before transferring the electrical load. After warm-up, place switch in GENERATOR position.

**NOTICE**

DO NOT allow the generator to run out of fuel. Fuel injected generators require air to be removed from the fuel delivery system before initial start-up or if the generator is allowed to run out of fuel. Continued attempts to start the generator with air in the fuel system can lead to engine damage or erratic operation. Air must be purged by your servicing dealer only.

To start the generator:

1. Open all hatches to the bilge area. Investigate and remedy any fuel vapors that are detected.
2. Check the generator oil and coolant levels.
3. Open the generator raw water seacock.
4. Open the diesel fuel supply valve. The fuel valve is located on the fuel tank in the starboard aft mechanical space.
5. Switch OFF the main breakers labeled BUS A and BUS B SHORE and GEN on the AC distribution panel (located in the head compartment electrical cabinet).
6. Switch ON all breakers except the OIL CHANGE PUMP breaker (if installed) on the Master DC Panel in the mechanical space.
7. Switch ON the main battery switches—PORT BATTERY, STBD BATTERY, CENTER BATTERY (if installed), and HOUSE BATTERY—on the DC distribution panel (located in the head compart-

ment electrical cabinet).

8. Turn ON the BLOWER button at the helm. Run the blower for five minutes prior to starting the generator.
9. Press and hold the START button on the generator control panel or the remote control panel (located in the head compartment electrical cabinet) until the generator starts. The generator status light will blink and the display will read 'STARTING' while the engine is preheating and cranking. The generator status light will stay on and the display will read 'RUNNING' once the generator starts and is running.

**CAUTION**

If the generator fails to start after 60 seconds of cranking, cease operation. Before attempting to crank again, drain the water from the generator's muffler. Failure to do so could result in raw water contamination of the generator's cylinders and damage the engine.

10. Switch ON the GENERATOR breakers on the AC distribution panel. The boat's AC system is now being powered by the generator.

To stop the generator:

1. Switch OFF the GENERATOR breakers on the AC distribution panel.
2. Allow the generator to run for two minutes without load to cool down.
3. Press and release the STOP button on the remote generator control panel or the panel on the generator.

4.12 Electrical System Maintenance**DC Electrical System Maintenance**

At least semi-annually, spray all exposed electrical components behind the helm and

in the plugs with a protector specific for electrical connections.

Make sure to check that all below-deck wiring is properly supported, the insulation is sound, and there are no loose or corroded terminals. Clean any corroded terminals thoroughly with sandpaper, or replace them. Tighten securely and spray with a metal and electrical protector. Inspect all engine wiring.

Check the electrolyte level in the batteries regularly and add distilled water as necessary. If the batteries are frequently charged by a battery charger, check the electrolyte level more often. The correct fluid level in the cells is approximately 1/4 to 1/2 inch above the plates. If fluid is needed, fill to the proper level with distilled water ONLY. DO NOT over-fill. Some batteries are sealed and cannot be filled.

Keep the tops of any battery clean and dry. Dirt and water can conduct electricity from one post to the other and can cause battery discharge or engine warnings.

DANGER

FIRE OR EXPLOSION HAZARD

Explosion or fire from hydrogen gases produced by lead acid batteries will cause death or serious injury. DO NOT smoke or bring a flame near the battery storage area. If ignited by a spark or flame, gas may explode violently, causing spraying of battery acid or fragmentation of the battery.

Keep the battery posts free of corrosion. DO NOT use wing nuts to attach battery cables. Remove the cables and clean the posts and cable clamps with a battery post cleaner or sandpaper as required. Coating the battery posts and cable clamps with petroleum jelly or silicone grease will help protect them and reduce corrosion. Battery cables, both positive and ground, must be replaced when they

show signs of corrosion or fraying. Deteriorated cables cause a considerable voltage loss when high currents are drawn, such as when starting the engine. See the battery owner's manual for maintenance information.

AC Electrical System Maintenance

Inspect all wiring insulation for nicks, chafing, brittleness, improper support, etc., periodically. Inspect portable appliance cords and plugs.

Examine the shore power cord for cracks in the insulation and corrosion in electrical connectors. Spray receptacles and electrical connections with an electrical contact cleaner or a metal and electrical protector to help reduce corrosion and improve electrical continuity.

GENERAL PRECAUTIONS

- Whenever possible, have electrical work done by a qualified electrician or your Tiara Yachts dealer.
- DO NOT work on an energized system; make sure all power sources are off.
- DO NOT allow unqualified personnel to perform electrical maintenance; only a qualified marine electrician should work on the electrical system.
- DO NOT work in a wet area.
- Use caution when connecting wires, in order to avoid reversing polarity.
- DO NOT alter wires or connectors, or use inferior parts. Use OEM replacement parts only.

Corrosion on the electrical connectors can cause poor connections, shorts and ground faults, and/or poor ground connections. Check at least annually and clean as required. DO NOT allow corrosion to build on connections.

Inspect all terminals and make sure they are tight.

Have the entire AC circuitry and the shore power cord tested every season by an experienced marine electrician. This will detect any shorts, open wires, or ground faults. Also, have the polarity indicator system inspected for proper operation.

Test all outlets periodically by pressing the test/reset buttons in the center of the face plate to ensure proper operation.

The engine maintenance required on the generator is similar to that required for the main engines. The most important factors affecting the generator's longevity are proper ventilation and the maintenance of the AC alternator and the fuel, ignition, cooling and lubrication systems. Maintenance schedules and procedures are outlined in your generator owner's manual; follow them exactly.



DANGER

ELECTROCUTION, FIRE OR EXPLOSION HAZARD

Contact with live wires or working on an energized electrical system will cause electrocution. It can also cause sparks, resulting in fire and/or explosion. Both cases will result in death or serious injury. DO NOT work on an energized system or allow unqualified personnel to work on the system.

Plumbing Systems

5.1 Freshwater System

The freshwater system consists of two potable water tanks, distribution lines, and a distribution pump. The pump is equipped with an automatic pressure switch.



Fresh water pump, in the mechanical space

The tanks are filled through the labeled deck fill on the starboard gunwale.



Water tank(s) deck fill

Operation

DO NOT confuse other deck fills with the freshwater fill. If toxic fluids or fuel is added to a freshwater tank, the system will be contaminated. DO NOT attempt to pump fuel out; this system is not designed to pump fuel. Fuel must be removed by qualified personnel only. Fuel in the freshwater systems will also require replacement of that system and/or many components.

! DANGER

FIRE OR EXPLOSION HAZARD
 Fuel and their vapors are highly explosive when exposed to open flame or spark, resulting in death or serious injury. Do not confuse deck fills.

! WARNING

HEALTH HAZARD
 Disinfect the entire fresh (potable) water system prior to first use, and annually at the beginning of each season. Failure to do so can result in developing coliform bacteria or other disease-causing organisms (pathogens) in the water system. Consumption of contaminated water could result in severe personal injury or death.

Follow the instructions in section 5.2, Freshwater System Commissioning, to disinfect the system at the beginning of each season. Once the system is commissioned, to refill the water supply tank(s), use a dockside hose and fill the tank(s) slowly through the labeled freshwater fill on the starboard gunwale. The tanks should be filled until water runs out of the vent located on the hull side just below the fill. After filling the tank(s), partially open all faucets. Switch ON the FRESH WATER PUMP switch on the DC distribution panel, located in the head compartment electrical cabinet. Allow the pump to run until all of the air is purged from the system and a steady stream of water is flowing from each outlet. Next, turn off the faucets one by one. As the pressure builds, the pump will automatically shut off.

When properly primed and activated, the water system will operate like the water system in a home. An automatic pressure sensor keeps the system pressurized. If the system

has been recently filled or has not been used for an extended period, air may accumulate at the pump and the system may have to be re-primed.

Whenever the boat is left unattended, turn the FRESH WATER PUMP switch OFF.

! CAUTION

DO NOT allow the fresh water pump to run dry; damage to the pump can occur. The fresh water pump works on demand and WILL NOT shut off when the tank is empty. Turn the water pump switch OFF when the system is not in use. Operating any pump from a low-charged battery can lead to a pump failure. Keep the batteries properly charged. The fresh water system must be properly winterized prior to winter lay-up. Refer to winterizing directions in section 12, Seasonal Maintenance.

Sink and Shower Operation

To use the sinks or shower, switch ON the FRESH WATER PUMP switch on the DC distribution panel. Some minor variations in the water temperature and pressure may occur as the pump cycles.

The sinks drain overboard. Shower water drains to a sump pump system located in the bilge below the cabin floor. An automatic float switch in the shower sump controls the pump. After showering, let the cold water flow for a period of time to flush the drainage system of soap residue. The shower drain strainer should be cleaned regularly and the sump inspected periodically for accumulated debris that needs to be removed.

Water Heater

The water heater is located in the mechanical space. The water heater uses an AC element that is thermostatically controlled at the heater. A high pressure relief valve protects the system from excessive pressure.

To use the water heater, the WATER HEATER breaker on the AC distribution panel (installed in the head compartment electrical cabinet) must be ON. Make sure all air is purged from the water heater and lines before activating the water heater breaker. Refer to the water heater manual for additional information.



Water heater (typical)

! CAUTION

DO NOT turn on the water heater until it is filled and primed; damage to the heater will result.

5.2 Freshwater System Commissioning

The freshwater system must be disinfected before first use, and annually at the beginning of each season. A clean, sanitized freshwater system will greatly reduce the risk of developing coliform bacteria or other disease-causing organisms (pathogens), and will help protect the health of everyone onboard.

To drain the system of antifreeze (if used):

1. Open all sink and shower faucets (hot and cold). Set single faucets to the warm position.
2. Switch ON the FRESH WATER PUMP breaker(s), located on the DC distribution panel (installed in the head com-

- partment electrical cabinet). The pump is self-priming.
- When anti-freeze stops flowing out of the faucets, switch the pump breaker OFF. Do not close faucets.
 - Fill the freshwater tank(s) with clean, fresh water using the deck fill fitting labeled WATER. The tank(s) should be filled until water runs out of the vent located on the hull side just below the fill.
 - Keeping all faucets open, switch ON the freshwater pump breaker and empty the water tank(s). When the water tank(s) is empty turn the pump breaker(s) OFF.
 - Repeat steps 4 and 5 until all nontoxic potable water antifreeze is removed from the system.

- it following the instructions provided previously.
- Close all faucets.
 - Prepare a chlorine sanitizing solution: in a container with 1 gallon of fresh water, mix 1/4 cup of Clorox® or Purex® regular unscented household bleach (5% sodium hypochlorite solution) for each 15 gallons of water tank(s) capacity.

<i>Tank capacity vs. cups of bleach</i>	
Water Tank Capacity	Cups of Bleach
15 Gal	1/4 Cup
30 Gal	1/2 Cup
45 Gal	3/4 Cup
60 Gal	1 Cup
75 Gal	1-1/4 Cups
90 Gal	1-1/2 Cups
105 Gal	1-3/4 Cups
120 Gal	2 Cups
135 Gal	2-1/4 Cups
150 Gal	2-1/2 Cups

WARNING

HEALTH HAZARD

Disinfect the entire fresh (potable) water system prior to first use and annually at the beginning of each season. Failure to do so can result in developing coliform bacteria or other disease-causing organisms (pathogens) in the water system. Consumption of contaminated water could result in severe personal injury or death.

CAUTION

Notify all persons aboard that the fresh water system is being sanitized. Do not allow anyone to drink from the fresh water system during the sanitizing process.

To disinfect and commission the fresh-water system:

- Ensure the water system, including the water heater and pump, is drained completely. If the system was filled with nontoxic antifreeze before storage, drain

- Fill the freshwater tank(s) halfway with clean, fresh water.
- Pour the sanitizing solution into the water tank(s) through the deck WATER fill fitting.
- Fill the freshwater tank(s) with clean, fresh water using the deck fill fitting labeled WATER. The tank(s) should be filled until water runs out of the vent located on the hull side just below the fill.
- Switch ON the freshwater pump breaker(s).
- At each faucet, run about 1/2 gallon of water out of each tap (hot and cold), then close the tap. You should be able to smell chlorine out of each tap.
- Switch OFF the FRESH WATER PUMP breaker(s) on the DC distribution panel, located in the head compartment electrical cabinet.

10. **Allow the chlorine sanitizing solution to sit in the system for three (3) hours.** A shorter time period will require a greater concentration of chlorine sanitizing solution to disinfect the water system.
 11. Switch ON the FRESH WATER PUMP breaker(s).
 12. Drain the chlorine sanitizing solution: open all faucets (hot & cold), set single faucets to the warm position, and empty the water tank(s). Ensure the water system, including the water heater and pump, is drained completely. When the water tank(s) is empty turn the pump breaker(s) OFF.
 13. Fill the freshwater tank(s) with clean, fresh water (see step 6). The tank(s) should be filled until water runs out of the vent.
 14. Keeping all faucets open, switch ON the FRESH WATER pump breaker(s) and empty the water tank(s). When the water tank(s) is empty turn the pump breaker(s) OFF.
 15. Fill the tanks again, until water runs out of the vent. Switch ON the FRESH WATER pump breaker and empty the tanks. Switch the breaker OFF.
 16. Final fill: Fill the freshwater tank(s) with clean, fresh water. The tank(s) should be filled until water runs out of the vent on the hull side just below the WATER fill.
 17. Switch ON the FRESH WATER PUMP breaker(s) and open all faucets. When a smooth flow of water is observed from each hot and cold tap, close the faucet. When all faucets are closed, the pump(s) will shut off as the system pressure increases. Any air should now be purged from the system.
- The freshwater system is now commissioned and ready for use.
1. Ensure the water tank(s) has enough available capacity to accept 10 additional gallons. If there is ample room in the tank(s), proceed to step 3, below. If not, continue to step 2.
 2. Drain at least 10 gallons of water from the system to make room for the vinegar solution (step 3). To do this, switch ON the FRESH WATER PUMP breaker(s) on the DC distribution panel, located in the head compartment electrical cabinet, and open a faucet. When at least 10 gallons have been drained, close the faucet and turn the pump breaker OFF.
 3. Prepare a solution of one (1) quart vinegar to five (5) gallons fresh water.
 4. Pour the vinegar solution into the water tank(s) through the deck WATER fill fitting.
 5. Allow the vinegar solution to agitate in the tank(s) for 24 hours.
 6. Switch ON the freshwater pump breaker and drain the vinegar solution by opening all faucets (hot & cold), setting single faucets to the warm position, and empty the water tank(s). When the water tank(s) is empty turn the pump breaker(s) OFF.
 7. Close all faucets.
 8. Fill the freshwater tank(s) with clean, fresh water. The fill fitting for the water tanks is installed on the starboard gunwale. The tanks should be filled until water runs out of the vent located on the hull side just below the fill.
 9. Switch ON the freshwater pump breaker(s) and open each faucet. When water flows smoothly from the hot and cold tap, close the faucet. When all faucets are closed, the pump will shut off as the system pressure increases. Any air should now be purged from the system
 10. Repeat if necessary.

To remove excessive chlorine taste or odor that might remain in the system, do the following:

5.3 Marine Head System

Your boat is equipped with a VacuFlush® marine head system. This system uses a small amount of water and a vacuum, which is powered by a 12-volt vacuum pump, to

flush. The toilet is connected to the pressurized freshwater system. Fresh water is used to reduce odor in the head compartment.

!
NOTICE

DO NOT operate the macerator dry; damage to the pump can occur. In some waters it is illegal to discharge waste overboard. Remove the sea-cock handle or use another method to prevent accidental discharge.

Before using the toilet, switch ON the VACUUM PUMP and FRESH WATER PUMP breakers on the DC distribution panel (located in the head compartment electrical cabinet). To use the toilet, lift the foot flush lever slightly to wet the bowl with the desired water level. Depress the flush lever all the way for approximately three seconds or until the bowl is clear. A sharp popping noise is normal when the vacuum seal is broken and flushing action begins. It is also normal for a small amount of water to remain in the bowl after flushing.

The waste is directed to the holding tank until it is pumped out by a waste dumping station or the optional overboard macerator discharge system (if installed). The waste moves through a small opening in the toilet base. Incoming air mixes with and fragments the waste as it passes through the base opening. This process eliminates the need for a macerator or mechanical motors in the toilet base. When the tank is full, the indicators on the tank monitor (located in the head compartment electrical cabinet) will show full and the vacuum pump will not run.

The vacuum generator may be accessed via the port aft bulkhead panel in the ski locker. The system vacuum is monitored by a vacuum switch, which is located on the vacuum generator tank. When the switch senses a drop in vacuum pressure in the system, it automatically signals the pump to energize and bring the vacuum back to operating level.

This process is normally completed in less than a couple minutes.

It is normal for the stored vacuum to leak down slightly between flushes, causing the vacuum pump to run for a short period. After the last flush, the pump should not run more than once every three hours to recharge the system. Refer to the head owner's manual for more information on the operation of the system.

Holding Tank

Monitor the holding tank level using the holding tank monitor (located in the head compartment electrical cabinet), and have the tank pumped out before it is completely full.



Holding tank monitor

Lights on the monitor will indicate the fill levels of the waste tank and freshwater tank. The graphic guide on the left of the panel indicates if the waste tank is full or empty. If the tank is allowed to overflow, the waste will overflow out the tank vent and overboard.

!
NOTICE

Some local regulations require overboard discharge systems to be physically secured in a closed position during use of the boat in waters designated as “no discharge” areas. Check with local boating regulations. Refer to the system user manual for additional information.

**NOTICE**

It is illegal to discharge raw sewage from a vessel within a three mile limit of the territorial waters of the United States of America. It is illegal to discharge raw sewage from a vessel within the navigable waters and rivers of the United States including the Great Lakes. When in international waters it is the responsibility of the vessel owner/operator to follow all local laws and restrictions.



Waste discharge seacock (typical)

To empty the waste tank:

1. At a marine facility pump-out station, remove the cap from the WASTE deck plate, located on the starboard forward gunwale, with the spanner wrench provided. Turn counterclockwise until the cap is loose; remove the cap and set it in a safe place.
2. Insert the pump-out station hose into the WASTE deck plate opening.
3. Turn the pump-out station pump equipment on. Remove all waste from the holding tank (check the tank monitor for progress).
4. Insert the pump-out station's water hose into the WASTE deck plate opening. Fill the tank with clean water and repeat steps 2 and 3.
5. Replace the deck plate cap and tighten with the spanner wrench.

To pump waste overboard (if your boat is equipped with the optional overboard discharge seacock):

1. Ensure your vessel is in a legal raw sewage discharge area.
2. Locate the overboard waste discharge seacock, installed in the forward storage compartment under the ski locker sole.
Note: The optional overboard discharge seacock is wired to the closed position at the factory.

3. Remove the cable tie securing the overboard discharge seacock.
4. Open the discharge seacock by pulling the handle to the vertical position.
5. Switch ON the WASTE PUMPOUT breaker on the DC distribution panel (located in the head compartment electrical cabinet). Allow the discharge pump to run until the waste tank is empty. The sound of the pump's motor load and speed will change when the tank becomes empty.
Note: Should the pump not activate, check to see that the seacock is in the OPEN position and that the WASTE deck plate cover is tightened securely. If not, the discharge system will not operate properly.
6. When the tank is empty, switch OFF the WASTE PUMPOUT breaker.
7. Close the overboard discharge seacock by pushing the handle to the horizontal position, and secure it. The overboard discharge seacock MUST be closed to prevent water from being forced back into the system.

Holding Tank Maintenance

The tank vent air filter is installed behind the port aft bulkhead panel in the ski locker. Replace the holding tank vent air filter annually for the most effective odor control.



Tank vent filter (typical)

Regularly clean and inspect the head for leaks. Periodically add chemicals to the head to help control odor and to chemically break down the waste. Refer to the head owner’s manual for additional operating and maintenance information.

NOTICE

The head and macerator systems must be winterized before winter lay-up; refer to section 12, Seasonal Maintenance.

5.4 Washdowns (optional)

If installed, the fresh water washdown uses water from the freshwater tank. The raw water washdown system pump is supplied by hoses connected to a ball valve and a thru-hull fitting located in the forward bilge, on centerline in the aft mechanical space. The raw water washdown draws sea water from a thru-hull installed in the hull bottom.

Raw Water Washdown Operation

If installed, the raw water washdown system pump is supplied by hoses connected to a ball valve and a thru-hull fitting located in the aft starboard mechanical space. The raw water washdown draws sea water from a thru-hull installed in the hull bottom.

CAUTION

When routing electric cables and dockside water hoses from the boat to the dock, be sure to allow sufficient slack so cables and hoses will not be strained in any way as the boat moves within its slip. Do not allow cables or hoses to dangle into the water.

Operation

To use the raw water washdown, connect a hose to the labeled connection under the helm seat. Make sure the ball valve is open before attempting to operate the raw water washdown system. Activate the pump by turning ON the WASHDOWN PUMP switch on the DC distribution panel (installed in the head compartment electrical cabinet). As pressure builds in the washdown hose, the pump will shut off.



Optional fresh and raw washdown inlets, under the helm seat

When the washdown hose is in use and the pressure drops, the pump will turn on. Turn the WASHDOWN PUMP breaker off when the washdown is not in use. The raw water washdown system is equipped with a sea strainer on the intake side of the pump, located in the mechanical space; check it frequently and clean as necessary.



Raw water strainer (left) and pump (typical)

Priming the System

Open the ball valve and switch ON the WASHDOWN PUMP switch on the DC distribution panel (installed in the head compartment electrical cabinet). Run the pump until all air is purged from the system. Close the thru-hull ball valve before the boat is hauled from the water to eliminate any air lock in the system. It may be necessary to re-prime the raw water system if the system is not used for an extended period.

CAUTION

DO NOT operate the high-pressure pump when dry, or damage to the pump will result. Turn the raw water pump switch OFF when leaving the boat unattended.

5.5 Drainage

Some of the drain thru-hull fittings are equipped with ball valves that are always open under normal operating conditions. Check and operate the drain valves at least once a month to make sure they are in good condition and operating properly. Also, check

the drain system to ensure it is free flowing and that the hoses on the thru-hull fittings are secure and not leaking.

Review and become familiar with the location of your boat's thru-hull drain valves.

In the event of an emergency, close the valves to prevent sea water from entering the boat through the drainage system. **NOTE:** Having one or more drain valves closed can be dangerous to the boat and all onboard. If this occurs, distribute PFDs and take all necessary safety precautions, including notifying the Coast Guard or local agency, until the problem is determined and corrected.

Bilge Drainage

The aft bilge pump is located to aft and centerline in the mechanical space; the mid pump is located forward to port in the mechanical space, and the forward pump is located under the aft ski locker floor hatch.

All bilge pumps pump water out of thru-hulls located above the waterline in the hull. A high water bilge alarm monitors excessive bilge water levels and signals a high water condition through a visual and audible alarm. Under this condition, the bilge pumps will be automatically activated and the boat horn will sound until the bilge water falls to a safe level. The high water alarm is installed in the starboard cabin lower electrical cabinet. See section 4, Electrical Systems, for additional information on bilge pump and high water bilge alarm operations.

Excess water in the bilge area will adversely affect the handling and maneuverability of the boat and can cause personal injury. Use the BILGE buttons at the helm to manually activate the bilge pumps briefly each time the boat is used to ensure pumps are operating properly. There is a delay built into the bilge pump's float switch before the pump will activate. Refer to the bilge pump and float switch owner's manuals for details.



Typical bilge pump and float switch (right)

Power is supplied to the automatic float switches on each bilge pump whenever the batteries are connected. Debris can prevent the pumps from operating or make it operate continuously. Make sure no debris is blocking the bilge pump float switches.

Inspect the bilge areas frequently for evidence of excessive water. Continuous operation of a bilge pump can indicate that there is excess water in the bilge or a leak, or that a drain plug is installed incorrectly. Test the bilge pumps at regular intervals. Bilge pumps and bilge pumping systems are not designed for damage control.

DO NOT allow the bilge pump to operate after all the water has been cleared from the bilge area, or damage to the pump will occur. When water has been cleared, turn OFF the BILGE buttons at the forward helm.

When the boat is out of the water, the bilge can be drained by unplugging the thru-hull drain located in the hull bottom near the transom. It is important to check the drain plug regularly to make sure it is tight. A loose drain plug will allow sea water to enter the bilge and cause the boat to sink. Check the drain plug frequently to make sure it is secure.

Any oil spilled in the bilge must be thoroughly removed and properly disposed of before operating the bilge pump. The discharge of oil from the bilge is illegal and subject to fine.



NOTICE

The US Federal Water Pollution Control Act prohibits the discharge of oil or oily waste into or upon the navigable waters of the United States or the waters of the contiguous zone if such discharge causes a film or sheen upon, or a discoloration of the surface of the water, or causes a sludge or emulsion beneath the surface of the water. Violators are subject to a penalty of \$10,000.

Exterior Drains

The cockpit sink drains by gravity to overboard thru-hulls.

The anchor locker drains overboard through a drain fitting located in the hull side at the bottom of the anchor locker. It is important to inspect the drain frequently to remove any accumulated debris.

5.6 Plumbing System Maintenance

Refer to your water system components owner's manuals for additional operation and maintenance information.

Freshwater System

Perform these routine maintenance procedures to maintain your freshwater system:

- Remove filter screens from faucet spouts and eliminate any accumulated debris. A debris build-up can cause the water pump to cycle excessively.
- Check and clean the freshwater system strainer (located on the intake line near the pump) at least annually.
- Test each bilge pump's float switch by holding two fingers over the raised circular areas of the switch for approximately 10 seconds to activate the pump.
- Remove the lid on the shower sump assembly, installed in the aft storage space

under the ski locker sole, periodically. Clean debris from the sump and flush with clean water. Activate the float switch to test the pump. Spray the pumps and metal components with a metal protector periodically.

- Add a commercially available potable water conditioner to the water tank(s) to keep it fresh.
- Make sure the FRESH WATER PUMP breaker on the DC distribution panel is switched OFF when leaving the boat unattended or when not in use.
- Change the freshwater filter, installed behind the head compartment sink access panel, annually.



CAUTION

Turn the DC distribution panel FRESH WATER PUMP breaker(s) OFF when leaving the boat unattended or when the fresh water system is not in use.

The water system must be winterized before storage. Refer to section 12, Seasonal Maintenance.

Raw Water System

Perform these routine maintenance procedures to maintain your raw water system:

- Check all hoses, and especially the sea water hoses, for signs of deterioration.
- Remove and clean the air conditioner and washdown pump sea water strainers, as needed. Spray the pumps and thru-hull valves with a metal protector periodically.
- Operate all thru-hull valves at least once a month to keep them operating properly.

If a hose ruptures or leaks, turn off the washdown pump, using the WASHDOWN PUMP breaker on the DC distribution panel, immediately. Keep the thru-hull valve closed when performing service on a sea water system.



CAUTION

Maintain a proper charge on the batteries; operating the pressure pump from a battery with a low charge could lead to pump failure.



CAUTION

If a hose ruptures, turn the WASH-DOWN breaker on the DC distribution panel OFF. Close the thru-hull valve before performing maintenance on the sea water pump. Operating any pump from a low-charged battery can lead to a pump failure. Keep the batteries properly charged. The raw water system must be properly winterized prior to winter lay-up. Refer to section 12, Seasonal Maintenance.

Raw Water Intake Strainers

The generator raw water intake, air conditioning raw water intake, and raw water washdown pump intake (if installed) are equipped with strainers. Check the strainers each time you use the boat to ensure that no debris has accumulated that may block the flow of water.

To clean clogged strainers:

1. Turn OFF the related engine or pump.
2. Close the raw water seacock, in the hull bottom, to stop the flow of water to the strainer.
3. Remove the filter basket cap by unscrewing it counterclockwise. A spanner wrench has been provided for this purpose.
4. Lift the filter basket out by the top handle.
5. Remove any debris from the filter basket and rinse with clean water.
6. Use only mild soapy water to clean the sight glass.

7. Check to be sure that the O-ring under the cap is intact and replace if necessary.
 8. Apply a waterproof grease that is silicon- or Teflon-based (do not use petroleum-based grease) to the cap threads and o-ring seasonally, to assure easy cap loosening for inspections and cleaning.
 9. Install the filter basket.
 10. Install the cap, and tighten by hand.
 11. Snug the cap with the spanner wrench.
 12. Open the seacock.
 13. Start the related engine or pump, and check the system for leaks.
 14. If the strainer is leaking, immediately close the related seacock and verify the filter cap is installed correctly with a good o-ring.
- Test each automatic bilge pump float switch each time the boat is used, for proper operation. Hold two fingers over the raised circular areas of the switch for approximately 10 seconds to activate the pump. Alternatively, add water to the bilge until the water level is high enough to activate the pump.
 - Test the high water alarm each time the boat is used. Press the TEST button on the alarm panel, located in the head compartment electrical cabinet.
 - Flush all gravity drains with fresh water periodically, to keep them clean and free-flowing.
 - Clean and inspect the shower and sink drain sump system periodically; the sump may be accessed by lifting the cabin floor hatch. Remove accumulated debris and flush with fresh water.



Water strainer (typical)

The raw water system must be winterized before storage. For more information, refer to section 12, Seasonal Maintenance.

Drainage Systems

Perform these routine maintenance procedures to maintain your drainage system:

- Clean the cockpit drain rails with a hose and water to remove all debris.
 - Clean the hardtop leg drain holes, especially before winter storage.
 - Clean the bilge pump of any debris.
 - Check the bilge for debris that can block the function of the automatic switch.
- Operate the thru-hull valves once a month and service as required.
 - Check the drain system regularly to ensure it is free-flowing and that the hoses on the thru-hull fittings are secure and not leaking.
 - Keep the o-ring on the insert end of the washdown hoses lubricated. Apply a mild liquid soap such as a liquid dish soap or boat wash to the insert on the hose end. For a long-term lubrication solution, apply petroleum jelly such as Vaseline. Apply a light coat to the hose connection and insert it into the washdown port. Depending on your location and usage, a monthly application may be necessary.



CAUTION

DO NOT use harsh chemical drain cleaners in drain systems; permanent damage to the hoses, fittings and system can result. Drains and pumps must be properly winterized before winter lay-up.

Ventilation Systems

Ventilation is supplied by opening portlights or using the air conditioning system.

6.1 Air Conditioning System (optional)

If equipped, the air conditioners can be operated to cool or heat, and are installed under the helm console (see section 2 for helm access information) and under the companion seat (accessible via the companion seat base air return grill). Do not store items in these compartments. Items stored on or immediately next to the air conditioning unit could cause damage to the air conditioner or be damaged by heat or condensation.

To operate the unit(s), first turn ON the AIR COND and AIR COND PUMP breakers on the AC distribution panel (installed in the head compartment electrical cabinet). The temperature is controlled using the climate control panels in the starboard cabinet aft of the berth.

A cold air return is located in the companion seat base. To obtain maximum efficiency from the air conditioner, do not obstruct the air return.

The air conditioner is self-contained and sea water cooled. The cooling pump supplies sea water to the unit, which cools the condensing unit and is discharged overboard. The pump is located in the mechanical space.



Air conditioning pump, strainer, and valve

Sea water is supplied to the pump from a thru-hull fitting located in the hull near the pump. A sea strainer between the pump and thru-hull fitting protects the system from contaminants that can damage the pump or the air conditioning system. Periodically clean the sea strainer basket to make sure the sea water pump receives adequate water.

Air locks can occur in the cooling pump water supply at the time of launching. If your boat has been recently launched and water is not flowing from the overboard thru-hull when the AIR COND PUMP breaker on the AC distribution panel is ON, air may need to be purged from the system. This can be achieved by making sure the valve at the cooling pump intake thru-hull is open. Then run the boat at cruise speed for several minutes. A scoop attached to the intake thru-hull will pressurize the system and force the air through the pump. Refer to the air conditioner owner's manual for additional operating and maintenance information.



NOTICE

Air conditioners use surface water to cool. DO NOT operate the air conditioner out of the water or without the raw water supply, or else damage to the system will occur. Confirm a water supply before operating the air conditioning. The lack of a water supply can also trip the circuit breaker.

6.2 Portlights

Portlights are secured by adjustable dogs. The dogs should be adjusted so they are tight enough to seal the window in the closed position, but not so tight that they are difficult to latch. The dogs are adjusted by turning a screw. The screw increases or decreases the pressure on each dog.

6.3 Carbon Monoxide

Read about carbon monoxide, its hazards, and the carbon monoxide detector in section 9, Safety Information.

6.4 Bilge Ventilation

Air flow into the bilge is supplied by a vent on the transom and through use of the mechanical space blower. To activate, use the BLOWER button on the helm.

6.5 Maintenance

- Periodically lubricate all hinges and latch assemblies with a light oil. Clean and coat gasket materials with silicone to help keep them pliable.
- The opening portlights are made of acrylic plastic. Acrylic can scratch easily. DO NOT use a dry cloth or glass cleaning solutions; use a soft cloth, mild soap, and water for routine cleaning. Solvents and products containing ammonia can permanently damage acrylic. Refer to the acrylic plastic information in section 11, Routine Maintenance, for directions for properly maintaining acrylic.
- Carbon monoxide detectors have a limited life span. The End of Life (EOL) date, five (5) years after the manufactured date, can be found on a sticker adhered to the body of the unit. Plan on replacing this unit prior to the EOL date. See the carbon monoxide detector owner's manual for more information.

Exterior Equipment

7.1 Forward Deck

 **CAUTION**

Unsecured open exterior doors and/or hatches can slam closed and cause injury or damage the boat. Most doors and hatches are equipped with fasteners, hatch lifters, snaps and/or straps to secure them open; make sure they are properly secured while they are open.

Rails and Deck Hardware

Rails and deck hardware perform specific functions. Do not use for securing fenders or mooring lines, which must be secured to the cleats. Make sure mooring lines are clear of rails or stanchions, or damage can result.

Cleats are flush-mounted and must be raised prior to use.

DO NOT use cleats or any other hardware for the purpose of towing or being towed. Inspect all hardware periodically for loosening, wear or damage. Repair or replace immediately.

 **WARNING**

The cleats on your boat have not been designed for, and are not intended to be used for, towing. Using them for this purpose could result in personal injury or damage to your boat. Refer to *Chapman Piloting & Seamanship* for proper towing procedures.

Anchor/Rope Locker

The anchor locker at the bow of the boat can be accessed through the forward deck hatch. An anchor chute and roller assembly is integrated into the bow stem. The chute and roller assembly is designed for a Delta plow type anchor. A chain snubber is provided to

secure the anchor during storage. Use the snubber to ensure the anchor chain is secure before getting underway. The anchor locker is drained by a thru-hull fitting in the hull side near the bottom of the locker. Check it frequently and keep it clean and free flowing.

The anchor must be securely stowed when not in use.

 **CAUTION**

Secure the anchor when it is stored in its locker and make sure it does not rest against the hull sides. If the anchor is loose, it will bounce and damage the boat. Damage from the anchor bouncing in the locker is not covered by the Tiara Yachts warranty.

Windlass

The windlass is located under the forward deck hatch in the anchor locker. The anchor is stored in the chute through the bow and is raised and lowered by the windlass. The anchor line is stored below the windlass and routed out through the windlass to the chain and anchor. The anchor locker is equipped with a receptacle for the windlass remote control.

 **WARNING**

MOVING PARTS OR ENTANGLEMENT HAZARD
Contact with moving parts can entangle and cut, resulting in loss of body parts, strangulation, and/or severe loss of blood, causing serious injury or death. Stay clear of moving parts.

Become familiar with the safe operation of the windlass before using it. Refer to the windlass owner’s user manual for operating instructions. Specifics regarding the proper techniques, equipment, and conditions for safe anchoring can be found in *Chapman*

Piloting & Seamanship, or through a boating safety course.

To operate the windlass, the WINDLASS breaker on the Master DC Panel in the mechanical space must be switched ON.

The anchor is lowered by releasing the anchor from the cleat or chain snubber in the locker, and activating the windlass using the remote switch in the anchor locker or the WINDLASS DEPLOY switch at the helm. After the anchor is set, do not allow the windlass to take the force from the anchor line; secure the rode to the cleat in the anchor locker.

CAUTION

DO NOT use the windlass as the only method of securing the anchor in the bow pulpit. Secure the anchor line to a cleat or chain snubber before operating your boat.

Boats at anchor in high swell conditions will snub on the anchor line. This can cause slippage or apply excessive loads to the windlass.



Windlass and anchor rode cleat (typical)

Windlasses are not designed to hold high loads while a boat is at anchor. When the windlass is not in use and the boat is at anchor, the rope rode must be properly tied off to the cleat inside the anchor locker. If

your boat is equipped with the optional all-chain rode, the rode must be secured using the chain stopper that is mounted forward of the windlass.

The anchor is retrieved by releasing the line from the bow cleat and activating the windlass using the remote switch in the anchor locker or the WINDLASS RETRIEVE switch at the helm. Once the anchor is retrieved, secure the anchor to the chain snubber or bow cleat to prevent it from being released while underway.

DO NOT use the windlass as a winch to move the boat over the anchor. Move the boat under its own power to the anchor and to break the anchor loose.

Foredeck Lounge

The foredeck lounge features seating with movable armrests and integrated drink holders, optional teak table, USB power ports, and storage below some cushions.

Weather covers are provided to protect the lounge and electronics when the boat is not in use. Snap the covers into place before leaving the boat. Remove and securely stow the covers before operating the boat.

Toy Storage

A large storage compartment is located in the starboard foredeck. To access, locate and release the latch that is mounted inboard of the forward-facing seat back, and fold the seat forward.

The toy storage compartment houses a fire extinguisher, a mount for storing the optional cockpit TV on the inboard bulkhead, and dedicated line storage, clip systems, and bungees for storing a variety of gear.

If your boat is equipped with the optional forward berth, see section 8, Interior Equipment, for details.



Toy storage compartment latch, above the starboard forward lounge seat armrest



Toy storage compartment, with TV storage mount (right)

Additional Storage

Storage space for sunshade poles and other gear is provided under the foredeck lounge cushions.

Forward Mediterranean-style Sunshade (optional)

An optional forward Mediterranean-style sunshade provides shade over the forward lounge. See the manufacturer's owner's manual for additional information.

To set up the sunshade:

- Locate the canvas shade and sun shade poles, stored under the forward lounge's forward-facing seat cushion.
- Locate the shade pole receptacles on the forward port and starboard gunwales, and at the bow.

- Press the release button to slide the cover plates out of the receptacles, and store them.
- Slide each pole base into its receptacle until it is latched in place.
- Attach the sunshade canvas to the underside of the forward hardtop overhang.
- Attach the sunshade canvas to the cords attached to the shade poles.
- Cinch the cords to tighten the sunshade.



Forward lounge sunshade (optional)

Stow the sunshade and poles during high winds or inclement weather; when underway above idle speeds; before transporting the boat overland; and before storing the boat.

7.2 Centerline Walkway

Bow Entry Door

Latch the door between the foredeck lounge and helm in the open or closed position at all times.

CAUTION

Keep the bow entry door secured in the open or closed position at all times. Failure to do so may result in personal injury or damage to the boat.

Windshield

Your boat is equipped with a custom, hinged fiberglass-framed windshield with tempered glass.

The hinged centerline windshield features an operable vent. Open the windshield to port and secure the pin into the locking mechanism found below the port windshield. Once the windshield is open, the top vent may be opened.

Close the vent before closing the windshield, or leave it in the open position. To close the windshield, release the locking mechanism. Secure the dogs on the aft (helm) side of the windshield.

The centerline windshield should be secured in the open or closed position at all times.

CAUTION

Keep the centerline windshield secured in the open or closed position at all times. Failure to do so may result in injury or damage to the boat.

Ski Locker

A large storage space for skis and other gear may be accessed by lifting the centerline walkway floor hatch. The ski locker's forward bulkhead panel provides access to the bow thruster. The forward floor hatch provides access to the holding tank overboard discharge seacock (if installed). The aft floor hatch provides access to the shower sump box, head macerator pump, and forward bilge pump. Remove the aft port bulkhead panel for access to the holding tank vent filter and head vacuum generator.

Water Washdowns

If equipped, the optional fresh and raw water washdown connections are located under the helm seat. To use a washdown connection, the WASHDOWN PUMP on the DC distribution panel must be ON. See section 5, Plumbing Systems, for more information.



Optional fresh water and raw water washdown inlets, located under the helm seat

CAUTION

When routing electric cables and dockside water hoses from the boat to the dock, be sure to allow sufficient slack so cables and hoses will not be strained in any way as the boat moves within its slip. Do not allow cables or hoses to dangle into the water.

7.3 Mid Cockpit

Helm Console

The helm console is the main operating position on your boat. A fold-out footrest platform is integrated into the console; unscrew the knurled knobs on either side to lower.



Fold-out footrest platform

A USB charging socket is installed on the helm console. Weather covers are provided to protect the helm console and electronics when the boat is not in use. Snap the covers into place before leaving the boat. Remove and securely stow the cover before operating the boat.

Helm and Companion Seats

The helm and companion seats feature flip-up bolsters. The helm seat can be adjusted fore and aft using the SEAT FWD/AFT switch located on the helm. The helm console features an integrated footrest.

The companion seat base features a fold-down footrest on the forward seat base.

The companion seat may be rotated to face the helm seat or the aft cockpit. Release the swivel lever found under the seat, and rotate the seat inboard and aft until it stops in one of two locking positions. Return the lever to the locked position. To return the seat to the forward-facing position, release the lever, rotate the seat, and lock in place.

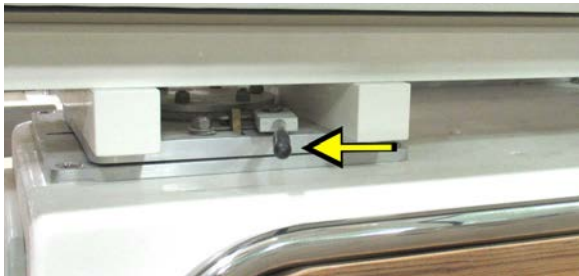

Companion seat rotation lever

Cockpit Accent Lighting

Multi-color, recessed accent rope lighting is installed throughout the exterior. See the lighting system owner's manual for more information. Control the lights using the black knob on the port side of the helm console.

- To turn the accent lights on, push and hold the knob for one second.
- To select the color, push the knob once and turn right or left.
- To adjust the brightness, push the knob a second time and turn right to increase or left to decrease.
- To select the speed of the color fade, push the knob a third time. Turn right to speed up or left to slow down.
- To turn off, push and hold the knob for three seconds.

Cooler Space

Space is provided under the helm seat for a 45-quart cooler.

Stereo

Operate the stereo using the receiver installed at the helm and the remote control panels in the foredeck lounge. For specific operating instructions, refer to the stereo user manual.

VHF Radio

The optional VHF radio is located outboard of the helm seat.

Helm Refrigerator, Freezer, or Ice Maker (optional)

If installed, the optional refrigerator, freezer, or icemaker is located underneath the companion seat. To operate, the REFRIGERATOR, ICEMAKER, or FREEZER breaker on the AC distribution panel must be switched ON.

Cockpit Air Conditioning (optional)

If installed, the cockpit air conditioning system is controlled using thermostats located outboard of the helm and companion seats. Refer to the climate control information in section 6, Ventilation Systems.

The cold air return is located under the companion seat. In order to obtain maximum efficiency for the air conditioning unit, do not obstruct this area.

7.4 Shore Power Connection

The shore power inlets are installed at the port transom. The shore power breakers are located in the port aft lounge seat base; lift the seat cushion to access.

See chapter 4 for electrical systems information.



Shore power and cable TV inlets

7.5 Mid Cockpit Galley

The galley includes a sink, optional grill, drawer refrigerator, storage drawer, 120V outlet, solid surface countertop, and waste-basket compartment (located inboard of the sink). The countertop includes a sink cover that may be stowed in a holder on the forward-facing side of the helm seat base.

Refrigerator

A dual-voltage drawer refrigerator is installed underneath the storage drawer in the cockpit galley. To operate, switch ON the COCKPIT REFRIG breaker on the AC distribution panel and the REFRIGERATOR breaker on the DC distribution panel. (Distribution panels are located in the head compartment electrical cabinet.) The temperature is controlled using the thermostat inside the unit. Refer to the refrigeration system owner's manual for more information.

Cockpit Grill (optional)

If installed, the 120/230V electric grill is located in the cockpit galley. The grill cover opens and locks into place.

To use the grill, turn ON the DECK GRILL breaker on the AC distribution panel, installed in the head compartment electrical cabinet. Turn the breaker OFF whenever the grill is not being used. Closing the grill lid automatically turns the breaker OFF. The grill must be allowed to cool before closing the grill

drawer, to avoid damage to the grill. Never clean the grill with any form of pressurized water or other types of cleaners. Use only a cloth and a stainless steel or glass surface cleaner. This grill, like all appliances, has the potential to create safety hazards through careless or improper use. Observe all of the safety precautions listed in the grill owner's manual.



WARNING

Severe burns can occur from the improper use of this device. Do not leave the grill unattended when it is hot. Close supervision is required when the grill is being used or is hot. Do not use the grill while underway.



NOTICE

After cooking, clean the grill surface. Empty the contents of the drip pan located below the grill. Lift the grill grate up and carefully remove the fully cooled drip pan. Allow the grill to cool off before closing the lid. Failure to do so could result in damage to the grill or grill area.



NOTICE

Do not set the grill lid over a warm grill. Allow the grill to cool completely before covering. Failure to do so could result in damage to the lid and grill.

Television (optional)

The optional television may be mounted in the galley. Dedicated storage for the TV is located in the foredeck toy storage compartment or berth, on the inboard bulkhead. Refer to the TV owner's manual for operating instructions. A television antenna is installed on the hardtop.

Galley Lounge

The galley lounge features seating and an expandable table; rotate the table top and flip open to expand.

Insulated Cooler Space

The starboard galley lounge seat base is insulated and may be used as a cooler.

7.6 Hardtop

The hardtop is designed to accommodate radio antennas, radar antennas, navigation lights and the horn. The hardtop is not designed to support the additional weight of items like an instrument locker or a life raft. Radar and electronics antennas must be mounted to the top between the windshield and rear legs. Do not mount any antennas or equipment to the brow area. The hardtop frame is not designed to support the weight of accessories in this area and can be damaged.

 CAUTION
<p>Care should be exercised to prevent damage to powder coated surfaces. If the surface is scratched, chipped or worn exposing the aluminum, it should be resealed to prevent corrosion from forming. If corrosion is allowed to form, it could cause the powder coating to bubble and lift away. Contact your dealer for repair service.</p>

The hardtop warranty will be voided if the top is modified in any way or heavy accessories are mounted to the top. Also, if items like radar antennas, spotlights and other accessories are mounted in the wrong location, the warranty can be voided. If you intend to add equipment or make modifications to the hardtop, contact Tiara Yachts Customer Relations to make sure the equipment you would like to

add or the intended modification will not void the hardtop warranty.

Sunroof

The hardtop sunroof, installed above the helm, may be opened and closed manually; unlock the handle and slide the sunroof aft to engage in the desired position. The sunroof handle should be engaged in a 'locked' position at all times.

Hardtop Lighting

The hardtop is equipped with overhead white and red LED lights. Use the overhead red lights when navigating at night. Operate the overhead lights using the HARDTOP WHT LTS and HARDTOP RED LIGHTS buttons on the helm.

Makefast Sun Shade

The Makefast® sun shade is electrically powered and extends to shade the aft cockpit. Activate the sun shade using the SUNSHADE OPEN and CLOSE buttons on the helm. The SUNSHADE breaker on the DC distribution panel (installed in the head compartment electrical cabinet) must be switched ON.

 CAUTION
<p>The sun shade must be retracted during severely windy conditions, or when boat speeds exceed 5 mph.</p>

7.7 Aft Cockpit

Fire Extinguisher and Storage

A fire extinguisher is located in the starboard aft-facing lounge seat base; lift the seat cushion to access. Storage space is provided under both aft lounge seats.

Cockpit Lighting

See 'Cockpit Accent Lighting' in section 7.3.

Aft Lounge Seating and Sunpad

The aft lounge features two seats that may be configured as sunpads. To configure either lounge as a sunpad, locate the floor pedal on the forward-facing seat base. Press the pedal with your foot to release the backrest. Move the backrest forward until it locks into the desired position, creating either a chaise lounge or sunpad.



Aft lounge seat floor pedal for adjusting the backrest position



Aft lounge seating



Aft lounge seating in chaise lounge position



Aft lounge configured as a sunpad

NOTE: The aft lounge seatbacks should be securely locked in the upright position any time the boat is underway. Do not run the engines or operate the boat unless the aft lounge seatbacks are in the fully upright position.



WARNING

Do not run the engines or operate the boat while the aft lounge is in the lowered sunpad position.

Mechanical Space Access

The center floor hatch in the aft cockpit provides access to the mechanical space.

Aft Cockpit Weather Covers

Weather covers are provided to protect the cockpit seating and helm console when the boat is not in use. Snap the covers into place before leaving the boat. Remove and securely stow the covers before operating the boat.

7.8 Stern

Boarding Steps

An integrated boarding step is located forward of each aft lounge seat.

Transom Door

Do not use the transom door when the boat is in motion. DO NOT leave the transom door unlatched. Always latch the door in the fully CLOSED position while the boat is underway. Latch it in the fully OPEN position or fully CLOSED position when the boat is not underway.



CAUTION

Periodically inspect transom door/gate fittings for wear, damage or loose fit. Repair or replace before using your boat.



NOTICE

Acrylic plastic scratches easily. Use a soft cloth and mild soap and water for routine cleaning. DO NOT use a dry cloth, abrasives, or glass cleaning solutions on acrylic. Solvents and products containing ammonia can permanently damage acrylic plastic.

The transom door features a clear acrylic panel. Use a soft cloth and mild soap and water for routine cleaning. **Do not use abrasive cleaners. Solvents and products containing ammonia, such as Windex®, can permanently damage acrylic plastic.**

Transom Shower

A fresh water shower is located outboard of the port transom step. It is supplied hot and cold water by the fresh water system and water heater.

To operate, switch ON the FRESH WATER PUMP breaker on the DC distribution panel and the WATER HEATER breaker on the AC distribution panel. (Distribution panels are installed in the head compartment electrical cabinet.) Pull the shower wand out of the holder and twist to start the flow of water and adjust the temperature. Before placing

the wand back in the holder, ensure the wand is shut OFF completely. Failure to do so will cause the fresh water pump to run and water to leak into the bilge.

Swim Platform

Your boat is equipped with an extended swim platform. A telescoping boarding ladder is installed under the port side swim platform hatch. A top-mount removable ladder may be attached to the starboard platform. The ladder is stored in the starboard aft seat base; access it by lifting the seat cushion.

DO NOT use the swim platform or ladder while an engine is running. All engines must be OFF when swimmers are in the water and before allowing anyone to enter or exit the boat. Stow the ladder before starting an engine.



DANGER

CARBON MONOXIDE POISONING AND/OR ROTATING PARTS HAZARD
Poisonous CO gases are present at the rear of the boat when an engine is running. A rotating propeller can cut or entangle swimmers. Either of these hazards will cause death or serious injury. DO NOT use the swim/boarding platform when the engine is running.

Interior Equipment

8.1 Safety Equipment

Familiarize yourself with the safety equipment found in the cabin. A smoke detector is mounted on the companionway steps.

8.2 Companionway

The head is accessed through the door forward of the companion seat. Use the latch to open the door and secure the door in the closed position. DO NOT leave the door unlatched.

 CAUTION
<p>Keep the head compartment door latched in the closed position. If the door is unlatched, it will move as the boat rocks, causing injury or damage.</p>

Companionway Switch Panels

Light switches outboard of the companionway step control the head compartment lights and accent lighting.

Electrical Cabinet

The AC and DC distribution panels, bilge high water alarm, remote generator control, climate control, and waste tank and water tank panels are housed in the head compartment electrical cabinet. See section 4, Electrical Systems, for more information.

Head Compartment

The head compartment is equipped with a toilet, fresh water sink with faucet, exhaust fan, waste basket, storage, AC GFI duplex outlet, and USB charger port. An operable portlight provides daylight and ventilation.

The countertop may be made of Corian®. Refer to section 11, Routine Maintenance, for Corian care information.

When the FRESH WATER PUMP breaker on the DC distribution panel is on, the water system will operate much like a home water system. Refer to section 5, Plumbing Systems, for more information on operating the system.

Marine Head System

Your boat is equipped with a VacuFlush® marine head system. Before using the toilet, ensure the VACUUM PUMP breaker on the DC distribution panel is ON. For more information, see section 5, Plumbing Systems, and the head system owner’s manual.

The holding tank monitor panel is located in the head compartment electrical cabinet. The indicators on this panel display the fresh water and waste holding tank levels. See the head user manual for more information.

8.3 Berth (optional)

Safety Equipment

Familiarize yourself with the safety equipment found in the berth (if equipped). A smoke detector and carbon monoxide detector are located in the headliner aft of the berth. The cabin fire extinguisher is stored inboard of the companionway step.

Read about carbon monoxide, its hazards, and the carbon monoxide detector in section 9, Safety Information.

 WARNING
<p>The carbon monoxide monitoring system is only a supplemental safety aid. Make sure you follow all safety procedures found in this manual. Carbon monoxide is a lethal, toxic gas that will cause death at certain levels.</p>

Light switches

Operate the berth lighting using the switches on the outboard wall.

Safety Information

9.1 General

Your boat and outboard engines have been equipped with safety equipment designed to enhance the safe operation of the boat and to meet U.S. Coast Guard safety standards. The Coast Guard and state, county, and municipal law enforcement agencies require certain additional accessory safety equipment on each boat. This equipment varies according to length and type of boat and type of propulsion. Most of the accessory equipment required by the Coast Guard is described in this section. Some local laws require additional equipment. Read *A Boat-er's Guide to the Federal Requirements for Recreational Boats*, published by the US Coast Guard and included with this manual, and obtain copies of state and local laws, to make sure you have the required equipment for your boating area. Visit www.uscgboating.org for more information. We also strongly recommend reading the latest edition of the book *Chapman Piloting & Seamanship*.

Your boat may be equipped with engine alarms and cabin monitoring equipment. These systems are designed to increase your boating safety by alerting you to potentially serious problems in the primary power systems, the engine compartment and the cabin. Alarm systems are not intended to lessen or replace good maintenance and a pre-cruise system check. Refer to the *Pre-Cruise Checklist* at the start of this manual, and sections 11 and 12 for maintenance information.

This section describes safety-related equipment that could be installed on your boat, depending on the type of engines and other options installed by you or your dealer.

9.2 Engine Alarms

Most outboards are equipped with an audible alarm system mounted in the helm area that monitors selected critical engine systems. The alarm will sound if one of these systems

begins to fail. Refer to the engine owner's manual for information on the alarms installed with your engines, as well as additional operating and maintenance information.

If the alarm sounds:

- Throttle the engines back to idle immediately.
- Shift to neutral.
- Monitor the engine gauges to determine the cause of the problem.
- If necessary, shut off the engines and investigate until the cause of the problem is found.
- If the boat is equipped with water sensors in the fuel filters, make sure to check them for excessive water.

9.3 Neutral Safety Switch

Every throttle/shift control system has a neutral safety switch. The switch allows the engines to be started in NEUTRAL only. If engines will not start, make sure controls are in NEUTRAL. Refer to section 2 for neutral safety switch information.

9.4 Engine Stop Switch

Your Tiara Yacht is equipped with an engine stop switch, clip and lanyard. When the lanyard is pulled, it will shut off the engines.

The stop switch will stop an engine whenever the lanyard is pulled far enough to disconnect the clip from the switch. Attach the lanyard to the boat operator whenever an engine is running, but be aware of loss of engine power if the switch is activated.

If the operator is thrown from the seat, or moves too far from the helm, the lanyard will disconnect the clip from the switch, shutting off the engine.

To attach a lanyard, connect the clip to the emergency stop switch and the hook to a strong piece of clothing on the operator, such as a belt loop.

**WARNING****LOSS OF CONTROL AND UNSAFE BOAT HAZARD**

An engine stop switch system that is not used or does not function correctly can cause death or serious injury. DO NOT operate the boat if the stop switch system does not function properly.

If the engines will not start, check to see if the clip isn't inserted into the engine stop switch properly or the control is not in neutral. Make sure the clip is properly attached to the engine stop switch before attempting to start the engine.

Always carry a spare stop switch clip and lanyard and instruct at least one other person onboard regarding the operation of the stop switch and location of the spare.

9.5 Fire Safety

Fire Extinguishers

Coast Guard-approved fire extinguishers are hand-portable, either B-I or B-II classification, and have a specific marine-type mounting bracket. It is recommended the extinguishers be mounted in a readily accessible position. Your Tiara Yacht comes equipped with the fire extinguishers in these locations:

- inside the starboard foredeck toy storage/optional berth compartment
- on the head compartment companionway steps
- in the aft cockpit starboard transom seat base

Check fire extinguishers at the start of each season and have them charged or replaced as necessary.

Fire extinguishers require regular inspections to ensure:

- Seals and tamper indicators are not broken or missing.
- Pressure gauges or indicators read in the operable range.
- There is no obvious physical damage, corrosion, leakage or clogged nozzles.

For information on the type and size fire extinguisher required for your boat, visit uscgboating.org or refer to *A Boater's Guide to Federal Requirements for Recreational Boats*, provided with this manual.

Information about halon or agent FE-241 extinguishers is provided by the manufacturer. It is extremely important that you learn about and understand and know how this system works; refer to the manufacturer's literature.

Automatic Generator Fire Extinguishing System

If your boat is equipped with a generator, an automatic fire extinguishing system is installed. It is extremely important that you learn about and understand how this system works; refer to the manufacturer's owner's manual for additional information.

**WARNING**

If a mechanical space fire should occur, turn off all main electrical switches and shut down the generator. Do not open the engine access hatch. Allow the fire extinguisher chemical to soak the engine compartment for at least fifteen (15) minutes.

The generator fire suppression system, located overhead in the port mechanical space, operates automatically. The extinguisher has been chosen and located to provide sufficient coverage of the generator

compartment. While the system helps ensure bilge fire protection, it does not eliminate the U.S. Coast Guard requirement for hand held fire extinguishers.

WARNING

FIRE/EXPLOSION HAZARD

The gas of the fire extinguisher system displaces oxygen to “smother” the fire. DO NOT open the hatch. Oxygen can feed a fire and flashback can occur, which can cause death or serious injury. If the onboard fire system discharges, wait at least 15 minutes before opening engine hatch.

The manual discharge pin is located outboard of the helm seat. To manually discharge the fire suppression system, remove the pin and pull the red handle.



Fire system manual discharge pull

The system is equipped with an engine shutdown circuit to automatically shut down the generator. The red light on the Fireboy status indicator (on the helm) will light and an alarm will sound if this should occur. Shut down all engines immediately. Turn off all electrical systems and powered ventilation, and extinguish all smoking materials. DO NOT open the engine compartment hatch, because this will feed oxygen to the fire and allow a flashback to occur. Allow the extinguishing agent to soak the generator compartment for at least 15 minutes and wait for hot metals or fuels to cool before inspecting for cause

or damage. Have an approved portable fire extinguisher at hand and ready for use and DO NOT breathe fumes or vapors caused by the fire.

After the fire suppression system discharges, turn on the BLOWER switch at the helm and operate the generator blower for five minutes. Open the mechanical space to evacuate the fire suppression agent and find and fix the problem.

To restart the engines, press the override button on the helm-mounted Fireboy system status indicator. Refer to the system owners manual for more information.



Fire system status indicator and override button

Bilge And Fuel Fires

Fuel compartment and bilge fires or explosions are dangerous because of the presence of fuel. You must make the decision to fight the fire or abandon the boat. If the fire cannot be extinguished quickly or it is too intense to fight, abandoning the boat may be your only option. You must consider your safety, the safety of your passengers, the intensity of the fire, and the possibility of an explosion in your decision.

If you find yourself in this situation, make sure all passengers have a life preserver, go over the side, and swim well upwind of the boat, to keep clear of any burning fuel that could be released and spread on the water as the boat burns or in the event of an explosion. When clear of the danger, check and account for all passengers who were onboard. Give whatever assistance you can to anyone in need or

in the water without a buoyant device. Keep everyone together for morale and to aid rescue operations.

9.6 Carbon Monoxide Safety

Carbon Monoxide Detector

A carbon monoxide detector is installed in the optional berth headliner. CO detectors warn occupants of dangerous accumulation of CO gas. If a carbon monoxide detector is activated, this indicates the presence of CO, which can be fatal. Evacuate the cabin immediately. Make sure all passengers are accounted for. DO NOT enter the cabin until you know it is safe to do so and the problem found and corrected.

The CO detector is powered by a 9v battery. A power light indicates that the detector is powered and working. Test the detector and replace the battery on a regular basis. Make sure the indicator light is on whenever the cabin is occupied.

This device uses a micro controller to continuously measure and accumulate CO levels. Should a very high level of CO exist, the alarm will sound within a few minutes. If small quantities are present or high levels are short-lived, the detector will accumulate the information and determine when an alarm level has been reached.

While a CO detector enhances your protection from CO poisoning, it does not guarantee it will not occur. Do not use CO detectors as a replacement for ordinary precautions or periodic inspections of equipment. Never rely on alarm systems to save lives; common sense is still the best form of protection. Remember, the boat operator carries the ultimate responsibility to make sure the boat is properly ventilated and passengers are not exposed to dangerous levels of CO. Be alert to the symptoms and early warning signs of carbon monoxide.

CO detectors are very reliable and rarely sound false alarms. If the alarm sounds,

DO NOT think it is false. If anyone has been exposed to CO, move them into fresh air immediately.

Contact the detector manufacturer, Tiara Yachts Customer Relations, or your local fire department for assistance in finding and correcting the situation. Never disable the CO detector because you think the alarm may be false.

Carbon Monoxide Hazards

Carbon monoxide (CO) is a by-product of combustion, is invisible, tasteless and odorless, and is produced by all engines and most heating and cooking appliances. It exists wherever fuels are burned to generate power or heat.

The most common sources of CO on boats are combustion engines, auxiliary generators, and propane or butane stoves. These produce large amounts of CO and should never be operated while sleeping. High concentrations of CO can be fatal within minutes. Many cases of CO poisoning indicate that while victims are aware they are not well, they become so disoriented they are unable to save themselves by either exiting the area or calling for help. Young children, elderly persons, and pets may be the first affected. Drug or alcohol use increases the effect of CO exposure. Individuals with cardiac or respiratory conditions are very susceptible to the dangers of CO. CO poisoning is especially dangerous during sleep while victims are unaware of any side effects.

Low levels of CO over an extended period of time can be just as lethal as high doses over a short period. Therefore, low levels of CO can cause the carbon monoxide detector to sound before persons notice any symptoms.

Carbon Monoxide Symptoms

All engines and fuel burning appliances produce CO as exhaust. Direct and prolonged exposure to CO will cause BRAIN DAMAGE or DEATH.

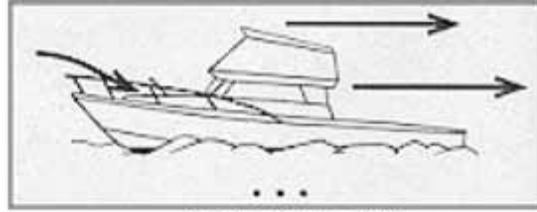

OPERATING SAFELY

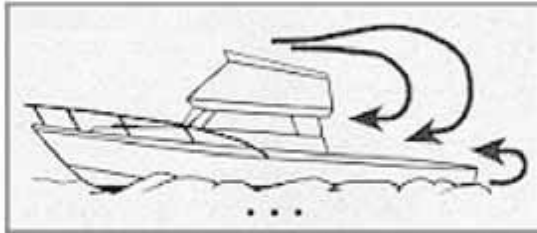

BACK DRAFTING / STATION WAGON EFFECT



NEARBY BOAT GENERATOR EXHAUST

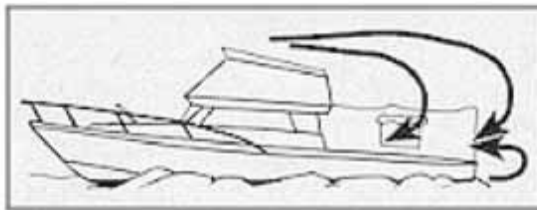

BACK DRAFTING / STATION WAGON EFFECT

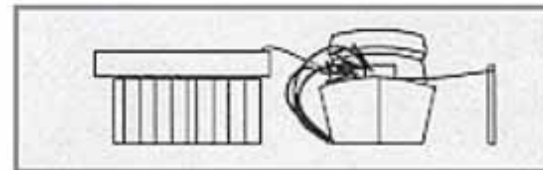

ONBOARD BOAT GENERATOR EXHAUST

Carbon monoxide (CO) poisoning is lethal and should not be confused with seasickness, intoxication, or heat exhaustion. If someone complains of irritated eyes, headache, nausea, weakness, or dizziness, or you suspect carbon monoxide poisoning, immediately move the person to fresh air, investigate the cause, and take corrective action. Seek medical attention if necessary.

dination, nausea, and unconsciousness. The victim's skin also may turn red. A slight buildup of CO in the human body over several hours causes headache, nausea, and other symptoms similar to food poisoning, motion sickness, or the flu. Anyone with these symptoms should immediately be moved to an area of fresh air. Have the victim breath deeply and seek immediate medical attention. To learn more about CO poisoning, contact your local health authorities.

DANGER

CARBON MONOXIDE (CO) HAZARD
 Exposure to CO will cause death or serious injury. CO is colorless, odorless and extremely dangerous. Avoid CO exposure and make sure the CO detector is working properly.

Preventing Carbon Monoxide Poisoning

In certain situations, boats can have a problem due to the "station wagon effect" where engine exhaust fumes are captured in the vessel by the vacuum or low pressure area (usually the cockpit, helm, and cabin) that can be created by the forward speed of the boat. When underway, all aft facing port-holes, hatches, and doors should be closed. Forward-facing deck hatches should be open whenever possible to help pressurize living

Other symptoms that may signal exposure to CO: dizziness, flushed face, ears ringing, headaches, tightness of chest or hyperventilation, drowsiness, fatigue or weakness, inattention or confusion, lack of normal coor-

spaces of the boat. Sleeping, particularly in aft cabins, should not be permitted while underway. Proper ventilation must be maintained at the helm by opening a forward window or windshield to drive fumes away from the occupants.

Use extreme caution when operating an auxiliary power generator while anchored or in a slip. Fumes can enter the boat easily on nights with calm wind. Inspect the exhaust systems of propulsion and the auxiliary generators, if equipped, frequently for possible leaks. High concentrations of CO in your boat can originate from an adjacent boat through open hatches or windows.

Failure to properly ventilate the boat while the engines are running can cause CO to accumulate within the cabin. Make sure to ventilate the boat and to avoid CO from accumulating in the boat whenever an engine is running.

Read the pamphlet *Carbon Monoxide Poisoning: What You Can't See*, included with this manual, and the owner's manual supplied by the CO detector manufacturer for additional information regarding the hazards and symptoms of CO gas, CO poisoning, and operation instructions. If you did not receive these manuals, contact Tiara Yachts Customer Relations.

CO detectors have a limited life span; follow the CO detectors manufacturers recommendations on when the detector must be replaced.

9.7 First Aid

It is the boat operator's responsibility to be familiar with proper first-aid procedures and able to care for minor injuries or illness of your passengers. In an emergency, you could be far from professional medical assistance, so be prepared. We recommend you be prepared by receiving training in basic first aid and CPR, through classes given by the American Red Cross or your local hospital.

Equip your boat with at least a simple marine first-aid kit and a first-aid manual. The marine first-aid kit should be designed for the marine environment and be well supplied. Keep it accessible so each person onboard knows where it is located. As supplies are used, replace them.

Ask a medical professional about the supplies you should carry and the safe shelf life of prescription drugs or other medical supplies you carry. Some common drugs and antiseptics can lose their strength or become unstable as they age. Replace old supplies whether they have been used or not.

In many emergency situations, the US Coast Guard can provide assistance in obtaining medical advice for treatment of serious injuries or illness. If you are within VHF range of a Coast Guard station, make the initial contact on channel 16 and follow their instructions.

9.8 Required Safety Equipment

In addition to items installed by Tiara Yachts, certain other equipment is required by the U.S. Coast Guard to help ensure passenger safety. Items like a sea anchor, working anchor, extra dock lines, flare pistol, life vests, or a line permanently secured to your ring buoy could at some time save your passengers' lives, or save your boat from damage. Visit www.uscgboating.org for a more detailed description of the required equipment and for information about boat safety courses. Check your local and state regulations as well.

The Coast Guard Auxiliary offers a courtesy inspection that will help ensure your boat is equipped with all of the necessary safety equipment. Visit uscgboating.org for details.

The following is a list of the accessory equipment required on your boat by the U.S. Coast Guard.

Personal Flotation Devices (PFDs)

PFDs must be Coast Guard approved, in good and serviceable condition, and of appropriate size for the intended user. Wearable PFDs must be readily accessible, meaning you must be able to put them on in a reasonable amount of time in an emergency. Though not required, the Coast Guard emphasizes that PFDs should be worn at all times when the vessel is underway. Throwable devices must be immediately available for use. All Tiara Yacht boats must be equipped with at least one Type I, II or III PFD for each person onboard, plus one throw-able device (Type IV).

Visual Distress Signals

All Tiara Yacht boats used on coastal waters, the Great Lakes, territorial seas, and those waters connected directly to them, must be equipped with Coast Guard approved visual distress signals. These signals are either Pyrotechnic or Non-Pyrotechnic devices.

Pyrotechnic Visual Distress Signals

Pyrotechnic visual distress signals must be Coast Guard approved, in serviceable condition and readily accessible. They are marked with a date showing the service life, which must not have expired. A minimum of three are required. Some pyrotechnic signals meet both day and night use requirements. They should be stored in a cool, dry location. They include:

- Pyrotechnic red flares, hand held or aerial.
- Pyrotechnic orange smoke, hand-held or floating.
- Launchers for aerial red meteors or parachute flares.

Pyrotechnics are universally recognized as excellent distress signals. However, there is potential for injury and property damage if not handled properly. These devices pro-

duce a very hot flame and the residue can cause burns and ignite flammable material. Pistol launched and hand-held parachute flares and meteors have many characteristics of a firearm and must be handled with caution. In some states they are considered a firearm and prohibited from use. Make sure you are careful and follow the manufacturer's instructions when using pyrotechnic distress signals.

WARNING

FIRE/EXPLOSION HAZARD

Pyrotechnic signaling devices can cause fire and/or explosion, death, serious injury and property damage if misused. Follow the manufacturer's directions in the use of these signaling devices.

WARNING

BURN HAZARD

Fuel floating on water which is ignited can cause death or serious injury. Fuel will float on top of water and can burn. If the boat is abandoned, swim upwind, far enough to avoid fuel that can spread over the surface of the water.

Non-Pyrotechnic Devices

Non-Pyrotechnic visual distress signals must be in serviceable condition, readily accessible, and certified by the manufacturer as complying with U.S. Coast Guard requirements. They include:

Orange Distress Flag, Day Use Only

The distress flag is a day signal only. It must be at least 3 x 3 feet with a black square and ball on an orange background. It is most dis-

tinctive when attached and waved from a paddle or boat hook.

Electric Distress Light for Night Use

The electric distress light is accepted for night use only and must automatically flash the international SOS distress signal. Under Inland Navigation Rules, a high intensity white light flashing at regular intervals from 50-70 times per minute is considered a distress signal.

Sound Signaling Devices

The navigation rules require sound signals to be made under certain circumstances. Recreational vessels are also required to sound fog signals during periods of reduced visibility. Therefore, you must have some means of making an efficient sound signal.

Navigation Lights

Recreational boats are required to display navigation lights between sunset and sunrise and other periods of reduced visibility (fog, rain, haze, etc.) Navigation lights are intended to keep other vessels informed of your presence and course. Your Tiara Yacht is equipped with the navigation lights required by the U.S. Coast Guard at the time of manufacture. It is up to you to make sure they are visible, operational and turned on when required.

9.9 Additional Safety Equipment

Besides meeting the legal requirements, prudent boaters carry additional safety equipment. This is particularly important if you operate your boat offshore. You should consider the following items, depending on how you use your boat.

Satellite EPIRBs

EPIRBs (Emergency Position Indicating Radio Beacon) operate as part of a worldwide distress system. When activated, EPIRB's will send distress code homing beacons that allow Coast Guard aircraft to identify and find them quickly. The satellites that receive and relay EPIRB signals are operated by the National Oceanic and Atmospheric Administration (NOAA) in the United States. The EPIRB should be mounted and registered according to the instructions provided with the beacon, so the beacon's unique distress code can be used to quickly identify the boat and owner.

Additional equipment to consider:

- VHF Radio
- Life Raft
- Spare Anchor
- Spare Keys
- Heaving Line
- Fenders
- First Aid Kit
- Portable Radio
- Flashlight and Batteries
- Mirror
- Searchlight
- Sunburn Lotion
- Tool Kit
- Ring Buoy
- Whistle or Horn
- Anchor
- Chart and Compass
- Boat Hook
- Spare Propellers
- Mooring Lines
- Food and Water
- Binoculars
- Sunglasses
- Marine Hardware
- Extra Clothing
- Spare Parts

Operation

10.1 General

Before operating your boat, become familiar with the various component systems and their operation, and perform the Pre-Cruise Checklist found near the beginning of this manual. A thorough understanding of the component systems and their operation is essential to operate the boat safely. This owner’s manual and the associated manufacturers’ owner’s manuals have been provided to enhance your knowledge of your boat. Read them carefully.

We also recommend reading the latest edition of the book *Chapman Piloting & Seamanship*, which describes the best procedures for leaving and returning to the dock. Your boat must have the necessary safety equipment onboard and be in compliance with the U.S. Coast Guard, local and state safety regulations. There should be one Personal Flotation Device (PFD) for each person. Non-swimmers and small children should wear PFDs at all times.

You should know and understand the “Rules of the Road” and have had an experienced operator brief you on the general operation of your new boat. At least one other person should be instructed on the proper operation of the boat in case the operator is suddenly incapacitated.

For information about boating safety, regulations, and navigation rules, download the Boating Safety Mobile App from the US Coast Guard. Visit www.uscgboating.org for more information.

The operator is responsible for his or her safety and the safety of his passengers. When boarding or loading the boat, always step onto the boat, never jump. While maneuvering around the dock, have all guests on board remain in the cockpit or cabin areas, if they are not involved in the handling of mooring lines.

DO NOT allow passengers to sit on the seat backs, gunwales, bows, transoms, or sunpads when the boat is underway. Passengers should be seated to properly balance the load and must not obstruct the operator’s view, particularly to the front.

 WARNING
<p style="text-align: center;">DROWNING OR LOSS OF CONTROL HAZARD</p> <p>Ejection or sudden loss of control can cause death or serious injury from improper use of seating. DO NOT stand while driving above engine idle speeds and make sure cockpit seating is locked/secured and all passengers are seated when boat is underway.</p>

Overloading and improper distribution of weight can cause the boat to become unstable and are significant causes of accidents. Know the weight capacity and horsepower rating of your boat. Do not overload or overpower your boat.

 WARNING
<p style="text-align: center;">OVERLOAD HAZARD</p> <p>Overloading the boat beyond maximum load or altering the stability, buoyancy or center-of-gravity can result in death or serious injury. DO NOT exceed the maximum load or alter the center-of-gravity of the boat.</p>

Remember, it is the operator’s responsibility to use good common sense and sound judgment in loading and operating the boat.

 WARNING
<p style="text-align: center;">SLIPPERY SURFACE HAZARD</p> <p>Wet surfaces can generate slippery conditions which can result in death or serious injury. Use caution on wet surfaces.</p>

10.2 Homeland Security Restrictions

Recreational boaters have a role in keeping our waterways safe and secure. Violators of the restrictions below can expect a quick and severe response:

- Do not approach within 100 yards, and slow to minimum speed within 500 yards of any U.S. Naval vessel. If you need to pass within 100 yards of a U.S. Naval vessel, for safe passage you must contact the U.S. Naval vessel or the Coast Guard escort vessel on VHF-FM channel 16.
- Observe and avoid all security zones.
- Avoid commercial port areas, especially those that involve military, cruise-line or petroleum facilities.
- Observe and avoid other restricted areas near dams, power plants, etc.
- Do not stop or anchor beneath bridges or in channels.

America's Waterway Watch

America's Waterway Watch, a combined effort of the Coast Guard and its Reserve and Auxiliary, wants your help in keeping America's waterways safe and secure. America's Waterway Watch urges you to adopt a heightened sense of sensitivity toward unusual events or individuals you may encounter in or around ports, docks, marinas, riversides, beaches or waterfront communities. To report suspicious activities, call the USCG National Response Center at 1-800-424-8802. If there is immediate danger to life or property call 911 or hail the Coast Guard on marine radio channel 16.

10.3 Rules of the Road

As in driving an automobile, there are a few rules you must know for safe boating operation. The following information describes the basic navigation rules and action to be taken by vessels in a crossing, meeting or overtaking situation while operating in inland waters.

These are basic examples and not intended to teach all the rules of navigation. For further information contact the Coast Guard, Coast Guard Auxiliary, Department of Natural Resources, or your local boat club. These organizations sponsor courses in boat handling, including rules of the road. We strongly recommend such courses. Books on this subject are also available from your local library.

Crossing Situations



CAUTION

Avoid collisions by following navigation rules. If a collision appears unavoidable, both vessels must act. Prudence takes precedence over right-of-way rules if a crash is imminent. Less maneuverable boats generally have the right of way. Steer clear of the right-of-way boat and pass to its stern.

In the illustration below, the boat on the right has the right of way and should maintain its course and speed. The other vessel should slow down and permit it to pass. Both boats should sound appropriate signals.

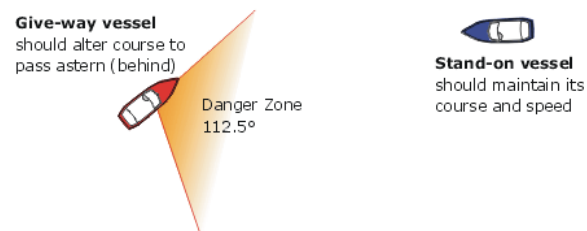

Overtaking Situations

When one motorboat is overtaking another motorboat, the boat being passed has the right of way. The overtaking boat must make adjustments necessary to provide clearance for a safe passage of the other vessel and should sound appropriate signals.

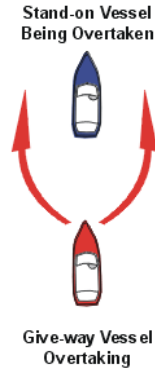

Meeting in Head-On or Nearly-So Situations

When two motorboats are approaching each other head-on or nearly head-on, neither boat has the right of way. Both boats should reduce their speed and turn to the right, passing port side to port side, providing enough clearance for safe passage. Both boats should sound appropriate signals.

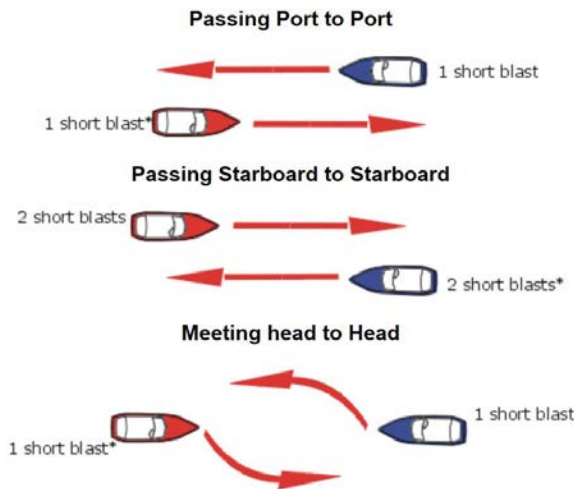

*Response not sounded on International Waters

The General Prudential Rule

In obeying the Rules of the Road, due regard must be given to all dangers of navigation and collision and to any special circumstances, including the limitations of the vessels, which may justify a departure from the rules in order to avoid immediate danger or a collision.

Navigation Aids

Aids to navigation are placed along coasts and navigable waters as guides to mark safe water and to assist mariners in determining their position in relation to land and hidden dangers. Each aid to navigation is used to provide specific information. Become familiar with these and any other markers used in your boating area.

Port Side Lateral System
As seen entering from seaward
(Green Light Only
Odd Numbered Aids)

Starboard Lateral System
As seen entering from seaward
(Red Light Only
Even Numbered Aids)

	Green Light Chart Symbol "1" Fl G 6s		Red Light Chart Symbol "2" Fl R 6s
	Green Lighted Buoy Chart Symbol G "9" Fl G 4s		Red Lighted Buoy Chart Symbol R "8" Fl R 4s
	Can Chart Symbol G C "7"		Nun Chart Symbol R N "6"
	Daymark Chart Symbol G "1"		Daymark Chart Symbol R "2"

CAUTION

Storms and waves can move buoys, do not rely on buoys alone to determine your position.

10.4 Operating your Boat

Familiarize yourself with the procedures outlined in the Pre-Cruise Checklist near the beginning of this manual. Be seated and ready with the controls (steering/throttle) when the engine is started or running.

After starting the engines:

- Check engine gauges. Make sure all are reading normally.
- Visibly check engines to be sure there are no apparent water, fuel, or oil leaks.

- Check operation of engine cooling systems.
- Check controls and steering for smooth and proper operation.
- Allow engines to warm up for 10 to 15 minutes before operating them above idle speeds.
- Make sure all lines, cables, anchors, etc. for securing the boat are onboard and in good condition. All lines should be coiled, secured, and off the decks when underway.

REMEMBER:

When operating a boat, you accept the responsibility for the boat and the safety of passengers and others out enjoying the water.

- Alcohol and any mind-altering chemicals can severely reduce your reaction time and affect your better judgment.
- Alcohol reduces the ability to react.
- Alcohol makes it difficult to judge speed and distance or track moving objects.
- Alcohol reduces night vision and the ability to distinguish red from green.

STAY ALERT. The use of alcohol or any other mind-altering chemicals that impair judgment pose a serious threat to you and others. The boat operator is responsible for their consequences and the behavior of passengers.

 WARNING
<p>IMPAIRED OPERATION HAZARD Operating any boat while intoxicated or under the influence of other drugs can cause death or serious injury. DO NOT operate any boat under the influence of any mind-altering chemical.</p>

Avoid sea conditions that are beyond the skill and experience of you and your crew.

Make sure at least one other person onboard is instructed in the operation of the boat and it is operated in compliance with all state and local laws.

DO NOT operate the boat unless it is completely assembled. Make sure all fasteners are tight and adjustments are to specifications.

Before operating the boat for the first time, read the engine break-in procedures. Refer to the engine owner's manual and have your dealer describe the operating procedures for your boat. For more information, refer to the engine owner's manuals.

If the drive unit hits an underwater object, stop the engine. Inspect drive unit for damage. If damaged contact your dealer for a complete inspection and repair of the unit.

For more instructions on safety, equipment and boat handling, enroll in one of the several free boating courses offered. For information on the courses offered in your area, visit the US Coast Guard Auxiliary website, cgaux.org, and download the Boating Safety Mobile App from the US Coast Guard, www.uscgboating.org.

After stopping the boat:

- Allow engines to drop to idle speed.
- Shift controls to NEUTRAL.

 CAUTION
<p>Turn off engines at idle speed. Racing the engine before switching it off can draw water into the engine through the exhaust, resulting in internal damage.</p>

If the engines have been running at high speed for a long period of time, allow them to cool by running at idle for 3 to 5 minutes.

- Turn the ignition OFF.
- Raise the trim tabs to full UP position.

After operation:

- If operated in saltwater, wash the boat and all equipment with soap and water. Flush the engines using fresh water. Refer to the engine owner's manual for instructions on flushing.
- Check the bilge area for debris and excess water.
- Fill the fuel tanks to near full to reduce condensation. Allow room in the tanks for the fuel to expand without being forced out the vent.
- Turn off all electrical equipment except the automatic bilge pumps.
- If you are going to leave the boat unattended for a long period of time, put the battery main switches to OFF and close all seacocks.
- Make sure the boat is securely moored.

CAUTION

To prevent damage, close all seacocks before leaving the boat.

10.5 Docking, Anchoring, and Mooring

Docking and Docklines

Maneuvering a boat near a dock and securing it requires skill and techniques that are unique to water and wind conditions and the dock layout. If possible, position a crew member at the bow and stern to assist with the lines and docking. While maneuvering close to the dock, compensate for wind and current, and anticipate how you can use them to help docking. Practice in open water using an imaginary dock to develop a sense for how the boat handles in different scenarios. You must be able to understand docking techniques before problems occur.

Approaching a dock or backing into a slip in high winds or strong currents requires skill. If you are new to handling a boat, take lessons from an experienced pilot and learn to

maneuver in tight quarters in less-than-ideal conditions. Also, practice away from the dock during windy conditions.

Dock lines are generally twisted or braided nylon. Nylon is strong and stretches to absorb shock. Nylon also has a long life and is soft and easy on the hands. The size of the line will vary with the size of the boat. Typically a 30-to-40 foot boat will use 5/8-inch line and a 20-to-30 foot boat will use 1/2-inch line. The number of lines and their configuration will vary depending on the dock, the range of the tide, and other factors. Usually a combination of bow, stern and spring lines is used to secure the boat.

Maneuvering to the Dock

Approach the dock slowly at a 30-to-40 degree angle. When possible, approach against the wind or current. Turn the engines straight and shift to neutral when you feel you have enough momentum to reach the dock. Use reverse to slow the boat and pull the stern toward the dock as the boat approaches. If you approached properly, the boat will lightly touch the pilings at the same time forward momentum is stopped. Have the dock lines ready and secure the boat as soon as it stops. Use fenders to protect the boat while it is docked. Keep the engines running until the lines are secured.

If your boat is equipped with joystick docking, consult your engine package owner's manual for additional instructions.

Backing into a Slip

Approach the slip with the stern against the wind or current and the engines straight ahead. Use the engines and turn the steering wheel to maneuver the boat into alignment with the slip. Reverse the engines and slowly back into the slip. Shift from reverse to neutral frequently at idle to prevent the boat from gaining too much speed. Move the stern right and left by shifting the engines in and out of gear or turning the wheel. When nearly in the

slip all the way, straighten the engines and shift to forward to stop. Keep the engines running until the lines are secured.

Securing Docklines

Securing a boat alongside the dock typically requires a bow and stern line and two spring lines. The bow and stern lines are usually secured to the dock at a 40 degree angle aft of the stern cleat and forward of the bow cleat. The after bow spring line is secured to the dock at a 40 degree angle aft of the after bow spring cleat. The forward quarter spring is secured to the dock at a 40 degree angle forward of the stern cleat. The spring lines keep the boat square to the dock and reduce fore and aft movement while allowing the boat to move up and down with the tide.

Securing a boat in a slip is somewhat different. It typically requires two bow lines secured to pilings on each side of the bow, two stern lines secured to the dock and two spring lines that prevent the boat from hitting the dock. The bow lines are typically secured with enough slack to allow the boat to ride the tide. The stern lines are crossed. One line runs from the port aft boat cleat to the starboard dock cleat and the other line runs from the starboard aft boat cleat to the port cleat on the dock. The stern lines center the boat, control the forward motion and allow the boat to ride the tide. Two forward quarter spring lines typically are secured to the stern cleats and to mid ship pilings or cleats. The spring lines keep the boat from backing into the dock while allowing it to ride the tide.

Leaving the Dock

Start the engines and let them warm up for 10 to 15 minutes before releasing the lines. Boats steer from the stern and it is important you achieve enough clearance at the stern to maneuver the boat as quickly as possible. Push the stern off and maneuver to gain stern clearance quickly. Proceed slowly until the boat has cleared the dock and other boats.

Mooring

Approach the mooring buoy heading into the wind or current. Shift to neutral when you have just enough headway to reach the buoy. Position a crew member on the bow to retrieve the buoy with a boat hook and secure the line. Keep the engines running until the line is secure.

Leaving a Mooring

Start the engines and let them warm up before releasing the mooring line. The boat will already be headed into the wind, so move it forward enough to loosen the line and untie it. Back the boat away until you can see the buoy and slowly move away.

Anchoring

Make sure the bitter end of the anchor rode is attached to the boat before dropping the anchor. Bring the bow into the wind or current and put the engine in neutral. When the boat comes to a stop, lower the anchor over the bow using the windlass. See section 7, Exterior Equipment. Allow enough rode so that it is at least 5 to 7 times the depth of the water and secure the line to a cleat. Use caution to avoid getting your feet or hands tangled in the line. Additional scope of 10 times the depth may be required for storm conditions. Check landmarks on shore to make sure the anchor is not dragging. If it is dragging, start over. It is prudent to use two anchors if you are anchoring overnight or in rough weather.



WARNING

SINKING OR DROWNING HAZARD
Anchoring at the stern can pull a boat under water. **DO NOT** anchor at the stern.

Releasing the Anchor

Release the anchor by traversing to the point where the anchor line becomes vertical. It should release when you pass that point. If

the anchor does not release, stop the boat directly above the anchor and tie the line to a cleat as tight as possible. The up and down movement of the boat will usually loosen the anchor. Make sure the anchor is secured and stowed before getting underway.

10.6 Controls, Steering, or Propulsion System Failure

The engine covers are machinery guards and must be in place whenever the engines are running. DO NOT operate the boat without the covers in place unless you are performing a check or maintenance.

If the propulsion, control, or steering system fails while you are operating the boat, bring both throttles to idle and shift to neutral. Determine if the boat should be anchored to prevent the boat from drifting or to hold the bow into the seas. Investigate and correct the problem if possible. Make sure the engines are off before investigating the problem. If you are unable to correct the problem, call for help.

WARNING

MOVING PARTS HAZARD

Contact with moving parts can entangle, cut, and cause death or serious injury. DO NOT come close enough to make contact with any running machinery moving parts, i.e., engine or propeller. Contact can result in loss of body parts, strangulation, burns and/or severe loss of blood resulting in serious injury or death.

In case of engine failure, you can operate the boat on one engine. Do not to apply too much power to the running engine. When running one engine to power a twin- or triple-engine boat, the engine will be ‘over propped’ and can be overloaded if too much throttle is applied. Contact your dealer or the engine manufacturer for the maximum power settings when running on one engine.

10.7 Collision

If your boat is involved in a collision with another boat, dock, piling or a sandbar, your first priority is to check passengers for injuries and administer first aid if necessary. Once all passengers’ situations are stabilized, thoroughly inspect the boat for damage. Check below decks for leaks and ensure all control systems for proper operation. Plug all leaks or make the necessary repairs to the control systems before proceeding. Operate slowly and carefully, taking all necessary precautions to be safe. Request assistance if necessary. Haul the boat and make a thorough inspection of the hull, lower unit, and control system for damage.

10.8 Grounding, Towing, and Rendering Assistance

The law requires the owner or operator of a vessel to render assistance to any individual or vessel in distress, as long as his vessel is not endangered in the process.

If your boat should become disabled, or if another craft that is disabled requires assistance, be careful. The stress applied to a boat during towing can become excessive. Excessive stress can damage the structure and create a safety hazard for all onboard.

Freeing a grounded vessel or towing a disabled boat requires specialized equipment and knowledge. Line failure and structural damage caused by improper towing have resulted in fatal injuries. We recommend that towing be done by those with the right equipment and knowledge, e.g., the U.S. Coast Guard or a commercial towing company.

The mooring cleats or bow/stern eyes on your boat are not designed or intended to be used for towing or lifting. These cleats are designed as mooring cleats for securing the boat to a dock, pier, etc. only. DO NOT use these fittings for towing, lifting, or attempting to free a grounded vessel.

When towing operations are underway, have everyone on both vessels stay clear of the tow line and surrounding area. DO NOT allow anyone to be in line with the tow rope; a dangerous recoil can occur if the rope should break or pull free.

Running aground can cause serious injury to passengers and damage the boat and its underwater gear. If your boat runs aground, evaluate the damage, then proceed at low speed to the nearest service facility and have an immediate inspection made before further use. A damaged boat can take on water; keep all life-saving devices close while heading to a dock area. If the boat cannot be immediately removed from the water, thoroughly inspect the bilge area for leaks.

10.9 Flooding or Capsizing

Boats can become unstable if they become flooded or completely swamped. Always be aware of the position of the boat to the seas and the amount of water in the bilge. Water entering the boat over the transom can usually be corrected by turning the boat into the waves. If the bilge is flooding because of a hole in the hull or the engine bracket, or a defective hose, you may be able to plug it with rags, close the thru-hull valve, or assist the pumps by bailing with buckets. Put a mayday call into the Coast Guard or nearby boats and distribute life jackets as soon as you discover your boat is in trouble.

If the boat becomes swamped and capsizes, you and your passengers should stay with the boat as long as you can. It is much easier for the Coast Guard, aircraft, or other boats to spot a capsized boat than people in the water.

10.10 Transporting your Boat

Your boat is large and should only be trailered by professionals with the right equipment and knowledge to transport large boats without causing damage. Contact your dealer or the Tiara Yachts Customer Relations Department if you are planning to transport your boat and

have any questions in regard to the proper equipment and support for the hull.

Damage from trailers can occur if the boat hull is not supported properly. Make sure the trailer bunks and pads are adjusted so they provide enough support for the hull and are not putting excessive pressure on the lifting strakes. Hull damage resulting from improper trailer support is not covered by the Tiara Yachts warranty.

10.11 Man Overboard

If someone falls overboard, be prepared to react quickly, especially when you are off-shore.

The following procedures will help you in recovering a person that has fallen overboard:

1. Immediately stop the boat, sound a 'man overboard' alarm and have all passengers point to the person in the water.
2. Circle around quickly and throw a throwable PFD, cushion, or life jacket to the person and, if possible, throw another to use as a marker.
3. Keep the person on the driver side of the boat to keep them in sight.
4. Approach the person from the downwind side and maneuver the boat so the propellers are well clear of the person in the water.
5. Turn off the engines when the person is alongside, and assist them to the boat using a ring buoy, boat cushion with a line attached, paddle, or boathook.
6. Pull the person to the boat and assist onboard.
7. Check for injuries and administer first aid if necessary. If the injuries are serious, call for help immediately.

Refer to section 9, Safety Information, for more information on first aid and requesting emergency medical assistance.

**DANGER**

CARBON MONOXIDE POISONING AND/OR ROTATING PARTS HAZARD
Poisonous CO gases are present at the rear of the boat when an engine is running. A rotating propeller can cut or entangle swimmers. Either of these hazards will cause death or serious injury. **DO NOT** use the swim/boarding platform when the engine is running.

10.12 Trash Disposal

Under the MARPOL agreement and U.S. federal law, it is illegal for any vessel to discharge plastic or garbage that contains plastics into any waters. It is also illegal to discharge garbage in the navigable waters of the United States including the Great Lakes.

Regional, state, and local restrictions on garbage discharges also may apply. Vessels of 26 feet or longer must display, in a prominent location, a durable placard at least 4 by 9 inches notifying the crew and passengers of the discharge restrictions. Responsible boaters store refuse in bags and dispose of it properly on shore. Make sure your passengers are aware of the local waste laws and the trash management procedure on your boat.

**NOTICE**

Any person who violates waste disposal requirements is liable for a civil penalty of up to \$25,000, a fine of up to \$50,000, and imprisonment for up to five years for each violation. Regional, state, and local restrictions on garbage discharges also may apply.

Read *A Boater's Guide to Federal Regulations for Recreational Boating*, provided with this manual, and visit www.uscgboating.org to learn about US federal regulations regarding trash disposal. Note that local laws may vary; it is your responsibility to understand the regulations in effect in your location.

10.13 Multi-Colored Lighting

Your vessel may be equipped with multi-colored LED cockpit accent lighting and/or underwater lights. **NOTE:** Caution should be taken when using multi-colored lights at night away from the dock. Red or green lights used at night could be confusing for other boats navigating nearby. On the water, blue lights are reserved exclusively for law enforcement vessels. The use of blue lights at night in open water, combined with boat movement, could cause confusion in a potential emergency situation, and may result in a fine.

Under the MARPOL agreement and U.S. federal law, it is illegal for any vessel to discharge plastic or garbage containing plastics into any waters. Additional restrictions on dumping non-plastic waste are outlined below. *All* discharge of garbage

is prohibited in the Great Lakes or their connecting or tributary waters. Each knowing violation of these requirements may result in a *fine* up to \$500,000, and up to 6 years imprisonment.

3 nautical miles from shore and anywhere in U.S. Lakes, Rivers, Bays, Sounds.

ILLEGAL TO DUMP Plastic
All other trash



3 to 12 nautical miles offshore

ILLEGAL TO DUMP Plastic
Dunnage, lining & packing materials that float. All other trash if not ground to less than one inch.

12 to 25 nautical miles offshore

ILLEGAL TO DUMP Plastic
Dunnage, lining & packing materials that float.

Outside 25 nautical miles offshore

ILLEGAL TO DUMP Plastic



State and local regulations may further restrict the disposal of garbage.

LET'S ALL DO OUR PART TO PROTECT THE OCEANS!



Routine Maintenance

11.1 General

 **WARNING**

FIRE/EXPLOSION/ASPHYXIATION HAZARD

Cleaning agents and paint ingredients can be flammable and/or explosive, or dangerous to inhale. Make sure ventilation is adequate, wear proper personal protection, and dispose of rags properly ashore.

Vapors from flammable solvents can cause fire, explosion, or asphyxiation, resulting in death or serious injury. Keep open flame or spark away from work area. DO NOT paint unless in a well-ventilated area.

Before using a cleaning product, refer to the product directions and specifications.

If urethane foam was used in the construction of your boat, be careful with high temperatures or flames in these areas. Urethane foam can ignite. DO NOT smoke, weld, or burn. Avoid the use of space heaters and lights in areas where urethane foam is present. If ignited, urethane foam burns rapidly, produces extreme heat, releases hazardous gases, and consumes much oxygen.

11.2 Exterior Hull and Deck

The exterior of your Tiara Yacht is made up of many different materials and finishes. Each material should be maintained by following the recommendations in the appropriate user manual.

After each use:

- Rinse the boat exterior with clean, fresh water.
- Wash all exterior surfaces and hardware

with a sponge or soft bristle brush and a solution of fresh water and mild detergent. Nonskid areas may be scrubbed with a stiff bristle brush.

- Rinse the boat with fresh water.

Apply a premium marine wax to all smooth (gel coat and/or painted) fiberglass surfaces at least once a year. Follow the directions supplied with the wax.

 **NOTICE**

Do not use abrasive cleaners on smooth fiberglass surfaces. They will dull the surface and allow dirt to penetrate the surface.

Most of the shiny white surfaces on your Tiara Yacht are gel coated. The deck, hardtop exterior and swim platform are a few examples. Depending on the build of your boat, the hull sides may be gel coated with a painted boot line or entirely painted. If you are unsure about your boat's finishes, contact your Tiara Yachts dealer.

Gel Coat

Time and exposure to sunlight may cause the gel-coated surfaces to fade, dull, or chalk. Regular applications of a premium marine wax will minimize this. If you find a noticeable chalking of the gel coat you may choose to have it buffed to bring back the original luster. We recommend contacting your Tiara Yachts dealer or other marine service facility if your finish needs attention.

 **CAUTION**

Experience is required to buff your boat. Do not buff your boat unless you have been properly trained and are using an industrial strength buffer with the appropriate pads and polishing materials.

After buffing, apply a coat of premium marine wax to all smooth surfaces, following the instructions included with the wax. Refer to the gel coat care card that came with your boat.

If the fiberglass or gel-coated surface should need repair, contact your Tiara Yachts dealer or another qualified marine service facility.

Axalta Marine Finish (optional)

Axalta[®] polyurethane marine finishes provide superior protection against the elements your boat will face throughout its long life. To ensure you maximize the benefits of the finish, use the following guide. If you are unsure about your boat's finishes, contact your Tiara Yachts dealer.

To maintain your painted hull finish:

- During the first 30 days following the boat's manufacture, when the finish is still fresh, clean the boat with a water rinse only.
- Do not wax for the first 60 days following the boat's manufacture.
- Do not use a pressure washer for the first 60 days following the boat's manufacture. Using high pressure while the paint is still fresh could affect the finish. Also avoid high pressure too close to areas with visible chips or cracks.
- Wash your boat often, especially when exposed to dusty, acidic or alkaline environments.
- When washing your boat, use non-abrasive, neutral pH (non acidic or alkaline) detergent. Do not use solvent-based solutions for washing.
- Do not wash the boat with extremely hot water or while the surface is hot.
- Avoid washing with stiff bristles. Soft cloth and soft brushes are recommended.
- Do not allow spilled gasoline, oil, anti-freeze, hydraulic fluid, or windshield washer fluid to sit on the paint or gel coat; remove immediately by rinsing with

water. With some oils and hydraulic fluids, the allowable exposure time before staining occurs is significantly shortened if the fluid or the painted surface is hot.

- Have any paint chips, nicks, or scratches repaired as soon as they occur to protect against future degradation.
- Should your boat's finish become damaged, have it repaired as soon as possible. Contact your Tiara Yachts dealer or a marine service facility and specify the same polyurethane marine finish as used for the original finish.

Bottom Painting

If your boat has not been ordered with factory-applied bottom paint, and will be kept in the water for three weeks or more at a time, the bottom should be painted with an antifouling paint. Because of variations in water temperature, marine growth and pollution in different regions, your Tiara Yachts dealer and/or a qualified boat yard in your area should be consulted when deciding what bottom paint system to apply to your hull, because pollution and marine growth can damage fiberglass hulls.

If your boat is equipped with a factory-applied first coat of bottom paint, a second coat should be applied over the first, just before launching. Paint has been provided by Tiara for this purpose. Follow the paint manufacturer's recommendations for preparation and application. Applying the second coat right before launching maximizes the paint's anti-fouling properties.

Sanding or sandblasting the hull bottom will damage the fiberglass. When preparing the hull for bottom paint, use only standard antifouling paints and fiberglass wax removers and primers recommended by the antifouling paint manufacturer. Sanding or sandblasting and the use of a coating other than standard antifouling paint or epoxy barrier coatings are not recommended and will void the hull blister warranty.

DO NOT allow antifouling paint to contact the outboard engines. Most antifouling paints contain copper which will cause severe galvanic damage to the motor. Leave a 1/2" (12.7 mm) barrier between the hull bottom paint and outboard engine.

Most bottom paints require maintenance, especially when the boat is in saltwater or not used for extended periods, or after dry storage. If the hull bottom has been painted with antifouling paint, contact your dealer for the recommended maintenance procedures.

Sacrificial Anodes

Sacrificial zinc anodes are installed on the trim tabs, transom, and outboard engines. The transom anode is connected to the bonding system and protects the underwater hardware that is bonded.

The anodes are less noble than copper-based alloys and aluminum and will deteriorate first, protecting the more noble underwater hardware against galvanic corrosion. Anodes should be checked monthly and changed when they are 75% of their original size. When replacing the anodes, make sure the contact surfaces are clean, shiny metal and free of paint and corrosion. Never paint over the anode or protect it.

Boats stored in saltwater will require anodes to be replaced at least every 6 months to one year. Anodes requiring replacement more frequently may indicate a stray current problem within the boat or at the slip or marina. Anodes that do not need to be replaced after one year may not be providing the proper protection. Loose or low quality anodes could be the problem. Contact your Tiara Yachts dealer for the proper size and type of anodes to be used and the specific installation procedure.

Fiberglass Gelcoat Surfaces

Normal maintenance requires only washing with mild soap and water. A stiff brush can be used on the nonskid areas. Kerosene or

commercially prepared products will remove oil and tar which could be a problem on trailered boats. DO NOT use harsh abrasive and chemical cleaners because they can damage or dull the gelcoat, reducing its life and making it more susceptible to stains. When the boat is used in saltwater, wash it thoroughly with soap and water after each use.

Sudden changes in temperature can affect gelcoat. When planning on moving your boat from outdoors to a heated location, allow the change of temperature to be gradual. Warm the location slowly after the boat is brought inside to allow the boat to change temperature slowly as the location is warmed. Or, if you are moving your boat from a warmer area to a colder one, wait for the temperature to be closer to the temperature of the warmer area or allow the warmer area and the boat to cool down.

At least once a season, wash and wax all exposed fiberglass surfaces. Use a high quality automotive or boat wax. Follow the procedure recommended by the wax manufacturer. Washing and waxing of your boat will have the same beneficial effects as they have on an automobile finish. The wax will fill minute scratches and pores, which helps prevent soiling and will extend the life of the gelcoat.

After the boat is exposed to the direct sunlight for a period of time, the color in the gelcoat will tend to fade, dull, or chalk from oxidation of the gel. This condition will be more apparent with dark colors, which require more frequent maintenance. A heavier buffing is required to bring the gelcoat back to its original luster. For power cleaning, use a light cleaner. To clean the boat by hand, use a heavier automotive cleaner. Before cleaning the surfaces, read the instructions given with the cleaner. After cleaning the surfaces, apply wax and polish all fiberglass surfaces except the nonskid areas.

If the fiberglass should become damaged and need repair, contact your Tiara Yachts dealer or an authorized repair person.

**WARNING****SLIPPERY SURFACE HAZARD**

Cleaning surfaces can generate slippery conditions which can result in death or serious injury. Use caution when cleaning with detergents. Rinse thoroughly.

Be careful when walking on wet gelcoat surfaces.

DO NOT wax nonskid surfaces, which could make them slippery and increase the possibility of injury.

Stainless Steel Hardware

When using the boat in saltwater, wash hardware with soap and water after each use. When your boat is used in a more highly corrosive environment—such as saltwater, water with a higher sulfur content, or polluted water—stainless steel may develop surface rust stains. This is normal under these conditions.

Clean and protect by using a high quality boat or automotive wax or a commercial metal cleaner and protectant. DO NOT use citrus-based or abrasive materials such as sandpaper, bronze wool, or steel wool on stainless steel, or damage will result.

Powder Coated (Painted) Aluminum Surfaces

Regular care is necessary to maintain the appearance of the powder coat finish. Build-up of salt and grime can hold moisture and damage powder coatings. This buildup can cause a corrosive condition that can damage the coating, especially in a salt air or coastal environment.

- Wash the finish regularly with warm water containing a pH neutral detergent (i.e. mild dish soap).
- Use a non-abrasive fiber cloth.
- Rinse thoroughly after cleaning.

Chrome Hardware

Rinse with fresh water and wipe dry with a towel or chamois after each use. Use a good chrome cleaner and polish on all chrome hardware. Clean and wax chrome prior to extended storage. In saltwater or other harsh environments, clean and wax more often.

Acrylic Plastic

Acrylic plastic scratches easily. DO NOT use a dry cloth or glass cleaning solutions on acrylic. Use a soft cloth and mild soap and water for routine cleaning. Solvents and products containing ammonia (including glass cleaners such as Windex®) can permanently damage acrylic plastic.

Fine scratches can be removed with a fine automotive clear-coat polishing compound. A coat of automotive or boat wax is beneficial to protect the surface.

**NOTICE**

Acrylic plastic scratches easily. Use a soft cloth and mild soap and water for routine cleaning. DO NOT use a dry cloth, abrasives, or glass cleaning solutions on acrylic. Solvents and products containing ammonia can permanently damage acrylic plastic.

DO NOT use the following on acrylic plastic:

- Abrasive cleaners
- Acetone
- Alcohol
- Cleaners containing ammonia
- Glass cleaners
- Solvents

Engines

Proper engine maintenance is essential to the performance and reliability of your out-board engines. Maintenance schedules and procedures are outlined in your engine owner's manual; follow them exactly.

Flush the system when the boat is out of the water. If the boat is used in saltwater, flush daily.

The age of the gasoline in your tank can affect engine performance. Chemical changes occur as the gasoline ages, causing deposits and varnish in the fuel system and reducing the octane rating of the fuel. Degraded fuel can damage the engine and boat fuel tank and lines. If your boat does not require at least one full tank of fresh fuel a month, add a fuel stabilizer to the gasoline to protect the fuel from degradation. Use only a fuel stabilizer recommended by your Tiara Yachts dealer or the engine manufacturer. Operate the boat at least 15 minutes after adding the stabilizer to allow the treated fuel to reach the engine. Your dealer or engine manufacturer can provide additional information on fuel degradation. For more recommendations for your specific area, check with your local Tiara Yachts dealer.

Avoid using fuels with alcohol additives. Gasoline, extended with an alcohol blend, will absorb moisture from the air which can reach such concentrations that “phase separation” can occur, where the water and alcohol mixture becomes heavy enough to settle out of the gasoline to the bottom of the tank. Since the fuel pick-up tube is near the bottom of the tank, phase separation can cause the engine to run poorly or not at all. This condition is more severe with methyl alcohol and will worsen as the alcohol content increases. Water or a jelly like substance in the fuel filters is an indication of possible phase separation from the use of alcohol blended fuels.

Contact your Tiara Yachts dealer or engine manufacturer for additional information regarding fuels and additives.

Corian Surfaces

Corian® is resistant to heat, but you should always use a hot pad or a trivet with rubber feet to protect it. Avoid exposing Corian to strong chemicals, such as paint removers, oven cleaners, etc. If contact occurs, flush the

surface with water immediately. Soapy water or ammonia-based cleaners will remove most dirt and stains from all types of finishes.

DO NOT use the Corian countertop as a cutting board.

Minor damage, scratches, general or chemical stains, scorches or burns and minor impact marks can be repaired on-site with a light abrasive cleanser and a product such as a Scotch-Brite® pad. For heavier damage, light sanding may be necessary. Heavy damage should be repaired by a Corian-licensed professional.

11.3 Seats and Upholstery

Seat Slides and Swivel Bases

Perform the following periodically:

- Inspect and tighten mounting screws between seat slides and seat bottom.
- Inspect and tighten the mounting screws attaching the seat bases to the boat.
- Keep a light film of grease on manual seat slides.
- Keep a light film of grease on manual seat-adjusting mechanisms.
- Clean electric seat slides. DO NOT use harsh chemicals or abrasives. Lubrication is not required.

Vinyl Upholstery

The vinyl upholstery used on the exterior seats and bolsters and the cabin headliner should be cleaned with soap and water periodically. Stains, spills or soiling should be cleaned up immediately to prevent the possibility of permanent staining. When cleaning, rub gently. DO NOT use products containing ammonia, powdered abrasive cleaners, steel wool, strong solvents, acetone, and lacquer solvents or other harsh chemicals as they can permanently damage or shorten the life of vinyl. Never use steam heat, heat guns, or hair dryers.

Stronger cleaners, detergents, and solvents may be effective in stain removal, but can cause either immediate damage or slow deterioration. Lotions, sun tan oil, waxes, and polishes, etc., contain oils and dyes that can cause stiffening and staining of vinyls. To clean common stains, follow these recommendations:

- Dry soil, dust and dirt: remove with a soft cloth.
- Dried-on dirt: wash with a soft cloth dampened with water.
- Variations in surface gloss: wipe with a water-dampened soft cloth and allow to air dry.
- Stubborn dirt: wash with a soft cloth, dampened with a delicate laundry soap and water. Rinse with clean water.
- Stubborn spots and stains: spray with Fantastik Cleaner® or Tannery Car Care Cleaner® and rub with a soft cloth. Rinse with clean water.
- Liquid spills: wipe with a clean absorbent cloth immediately. Rinse with clean water.
- Food grease and oily stains: spray with Fantastik Cleaner or Tannery Car Care Cleaner, wiping with a soft cloth immediately. Be careful not to extend the area of contamination beyond its original boundary. Rinse with clean water.

11.4 Cabin Interior

Clean the cabin interior just like you would clean a home interior. Use wood cleaner on teak woodwork and a vacuum cleaner on carpeting.

Air and sunlight are very good cleansers. Periodically, place cushions, bedding, etc., on deck, under the sun and in the fresh air to dry and air out. If cushions or equipment get wet with saltwater, remove and use clean, fresh water to rinse off the salt crystals. Salt retains moisture and will cause damage. Dry thoroughly and reinstall.

If you leave the boat for a long period of time, open all interior cabin and locker doors and hang a commercially available mildew protector in the cabin. Read the label on the mildew protector carefully and follow instructions. Remove the protector from the cabin and allow the cabin to ventilate completely before using the cabin again.

11.5 Bilge

To keep the bilge clean and fresh, use a commercial bilge cleaner regularly. Follow the directions carefully. All exposed pumps and metal components should be sprayed with a protector periodically to reduce the corrosive effects of high humidity.

	WARNING
<p>FIRE/EXPLOSION OR ASPHYXIATION HAZARD</p> <p>Fumes from flammable solvents can cause fire, explosion, or asphyxiation resulting in death or serious injury. DO NOT use flammable solvents to clean the bilge.</p>	

11.6 Electrical

The AC and DC electrical systems require routine maintenance. See section 4, Electrical Systems, for more information.

11.7 Generator

The engine maintenance required on the generator is similar to an inboard engine. The engine incorporates a pressure-type lubrication system and a fresh-water-cooled engine block which is thermostatically controlled. The most important factors affecting the longevity of the generator are proper ventilation and maintenance of the fuel system, ignition system, cooling system, lubrication system, and AC alternator.

Maintenance schedules and procedures are outlined in the generator owner's manual; follow them exactly.

Seasonal Maintenance

12.1 Winterizing

Engines

Refer to the engine owner’s manual for detailed information on preparing the engines for storage.

Fresh Water System

The entire fresh water system must be completely drained. Disconnect all hoses, check valves, etc., and blow all the water from the system. Make sure the water heater and fresh water tank are completely drained. Use only very low air pressure when blowing water from the system in order to prevent damage to components. The check valve mechanism built in the fresh water pump will not remove the water from the pump. Remove the outlet hose on the pump, turn it on, and allow it to pump out any remaining water (approximately a cupful).

Before storing your boat, the water system needs to be drained and winterized.

WARNING

Hot water will cause burns. Do not drain the freshwater system until water in the water heater tank (if installed) is cool.

CAUTION

Do not operate the water heater without water in the water heater tank. Failure to do so could damage the water heater.

To drain the fresh water system:

1. Switch OFF the WATER HEATER breaker on the AC distribution panel, if installed.

2. Open all fresh water faucets (hot and cold). Leave the faucets open.
3. Switch ON the FRESH WATER breaker(s) on the DC distribution panel.
4. Allow the water to run until the tank is empty. The tank is empty when all faucets no longer produce a stream of water.
5. Switch OFF the FRESH WATER breaker(s).
6. Remove the hoses from the input and output sides of the fresh water pump(s), and let the pump(s) and hoses drain into the bilge. The fresh water pump(s) are located in the mechanical space.
7. Switch ON the FRESH WATER breaker(s) for 3-5 seconds to remove the water from the bottom of the pump housing(s). Turn OFF the FRESH WATER breaker(s).
8. If installed, drain all water from the water heater. Refer to section 5, Plumbing Systems, and the water heater user manual for the draining procedure.

Next, flush the system with potable water antifreeze:

1. Close all fresh water system faucets.
2. Reconnect the hoses to the water pumps.
3. If an optional ice maker is installed:
 - Disconnect the ice maker water supply and plug the supply line.
 - Switch ON the ICE MAKER breaker on the AC distribution panel.
 - Allow the unit to run for an hour.
 - Remove any cubes that may have been ejected during this period.
 - Switch OFF the breaker and prop the ice maker door open to let the unit defrost.
 - After the ice maker has defrosted, wipe it dry.

NOTE: At no time should potable water antifreeze be allowed to enter the ice maker. Follow the ice maker user manual for winterization procedure.

4. Pour five (5) gallons of potable water antifreeze into the water tank via the WATER fill fitting(s) on the gunwale(s).
5. Turn both water heater valves (if installed) fully counter-clockwise to the bypass position.
6. Switch ON the FRESH WATER breaker(s) on the DC distribution panel.
7. Open all faucets in the system (hot and cold), one at a time, until the antifreeze begins to come out, and then close.
8. Switch OFF the FRESH WATER breaker(s).

An alternate method is to use commercially available nontoxic, fresh water system antifreeze. After draining the potable water tank, lines and water heater (if installed), pour the antifreeze mixture into the fresh water tank, then prime and operate the pump until the mixture flows from all fresh water faucets. Be sure to open ALL faucets, including the water supply valve for the head. Make sure antifreeze has flowed through all of the fresh water drains. Allow the antifreeze to fill the sink traps.

The shower/cabin drain sump system must be winterized also. Clean debris from the drain and sump and flush for several minutes with fresh clean water. After the system is clean, pump the drain sump as dry as possible. Then pour a potable water antifreeze mixture into the shower drain until antifreeze has been pumped through the entire system and out of the thru-hull.

For additional information, refer to section 5, Plumbing Systems.

Raw Water System

Drain the raw water systems completely. Disconnect all hoses and blow the water from the system. Use only very low air pressure when blowing water from the system to prevent damage to components. The check valve mechanism built into the raw water washdown pump will not remove the water from the pump. Remove the outlet hose on the pump, turn it on, and allow it to pump out

any remaining water (approximately a cupful).

An alternate method is to use commercially available nontoxic, potable water system antifreeze. If antifreeze is used, pour the mixture into a pail and put the raw water intake lines into the solution. Turn on the raw water washdown pump using the WASHDOWN PUMP breaker on the DC distribution panel, located in the head compartment electrical cabinet. Run the pump until the antifreeze solution is visible at all raw water faucets, discharge fittings, and drains. Make sure antifreeze has flowed through all of the raw water drains.

Generator Raw Water Systems

If a generator is installed on your Tiara Yacht, drain the sea strainer, heat exchangers, and raw water supply and discharge lines for the generator raw water supply pumps. Make sure all sea water has drained from the exhaust system. Some generator engine mufflers have a drain plug that must be removed to properly drain the muffler.

Once the exhaust system has been drained, pour a nontoxic marine engine antifreeze mixture into a large pail and put the generator raw water intake lines into the solution. Run the generator until the antifreeze solution is visible at the exhaust port, then shut the engine off.

Winterize the generator engine and fuel system by following the generator manufacturer's winterizing procedures. Refer to generator's owner's manuals or contact a Tiara dealer.

Fuel System

Leave the fuel tank nearly full to reduce condensation that can accumulate in the tank. Allow enough room for fuel to expand without leaking from the vents.

Algae can grow in the accumulated water in diesel fuel tanks, especially in warm climates. Adding a high quality diesel fuel additive con-

taining an algaecide may be required to control algae during storage.

Marine Toilet

Pump out the head. Flush the holding tank using clean soap, water, deodorizer, and pump-out cleaning solution.

Refer to the toilet owner's manual and winterize the toilet following the procedures exactly. Drain the intake and discharge hoses completely using low air pressure if necessary. The head holding tank and macerator discharge pump must be pumped dry. Pour one gallon of potable water antifreeze into the tank through the deck waste pumpout fitting. After the antifreeze has been added to the holding tank, open the overboard discharge valve and activate the macerator pump until the antifreeze solution is visible at the discharge thru-hull.

Air Conditioner

Disconnect and drain the air conditioner intake and discharge hoses. Remove all water from the sea strainer and thru-hull fitting. Allow all water to drain from the system. An alternate method is the use of commercially available nontoxic, potable water system antifreeze. If antifreeze is used, drain the sea strainer and pour the mixture into a pail and put the raw water intake line into the solution. Run the air conditioner until the antifreeze solution is visible at the discharge fitting on the hull side.

Air conditioner components must be winterized also; follow winterizing procedure in the air conditioner owner's manual.

Bilge

The bilge pumps and bilge pump lines must be completely free of water and dried out when the boat is laid up for the winter in climates where freezing occurs. Compartments in the bilge that will not drain completely should be pumped out and then sponged until completely free of water. Dry the hull bilge

and self-bailing cockpit troughs. Water freezing in these areas could cause damage. Coat all metal components, wire busses, connector plugs (in the bilge), strainers, seacocks, and steering components with a protecting oil. Wipe the bilge areas clean and dry.

Covering for Winter Storage

Proper storage is very important to prevent serious damage to the boat. If the boat is stored outside, support and secure a storage cover properly over the boat. It is best to have a frame built over the boat to support the cover. It should be a few inches wider than the boat so the cover will clear the rails and allow passage of air. If this cover is fastened too tightly there will be inadequate ventilation, which can lead to mildew, moisture accumulation, etc. Fasten the cover down securely so wind cannot remove it or cause chafing of the hull superstructure. DO NOT store the boat in a damp storage enclosure. Excessive dampness can cause electrical problems, corrosion, and excessive mildew.

DO NOT use the bimini top or convertible top cover in place of the winter storage cover. The life of these tops can be shortened if exposed to harsh weather elements for long periods.

DO NOT use an electric or fuel burning heating unit in the bilge area.

If the boat is to be stored indoors, make sure the building has enough ventilation and there is enough ventilation both inside the boat and around the boat. If the boat is to be stored indoors or outdoors, open all drawers, clothes lockers, cabinets, and interior doors a little. If possible, remove the upholstery, mattresses, clothing, and rugs.

12.2 Storage and Lay-up

It is essential that care be used when lifting your boat. Make sure the spreader bar at each sling is at least as long as the distance across the widest point of the boat that the

slings will surround. The sling positions are marked with small labels on each side of the boat under the rubrails. Tie fore and aft slings together to prevent slings from sliding on the hull.

Elevating lifts are commonly used to store boats for extended periods. To provide proper support, the bunks that support the hull should be aligned with and run parallel to the hull stringers. The bow and stern eyes, if equipped, should not be used as sole support for storage.

Your boat can be damaged from improper lifting and rough handling when being transported by lift trucks. Care and proper handling procedures must be used when using a lift truck to move your boat. DO NOT attempt to lift the boat with a substantial amount of water in the bilge.

	<h2 style="margin: 0;">CAUTION</h2>
<p>Failure to follow the proper lifting procedures while lifting your boat may result in structural damage to the hull and deck or underwater gear.</p>	

Severe gelcoat cracking or more serious hull damage can occur during hauling and launching if pressure is created on the gunwales (sheer) by the slings. Use flat, wide slings and spreaders long enough to keep pressure from the gunwales. DO NOT allow your boat to be hauled when the spreaders on the lift are not wide enough to take the pressure off the gunwales.

To prepare the boat for storage:

- Remove the bilge drain plug(s), if installed.
- Thoroughly wash the fiberglass exterior, especially the antifouling portion of the bottom. Remove as much marine growth as possible. Lightly wax the exterior fiberglass components.
- Remove all oxidation from the exterior

hardware and apply a light film of moisture-displacing lubricant.

- Remove propellers and grease the propeller shafts using light waterproof grease.
- Remove batteries and clean using clear, clean water. Make sure batteries have sufficient water and terminals are clean. Keep the batteries charged and stored in a cool, dry place and safe from freezing. See section 4, Electrical Systems, and the battery owner's manual for more information.
- Follow the AC and DC electrical systems maintenance instructions in section 4, Electrical Systems.
- Coat all faucets and exposed electrical components in the cabin and cockpit with a protecting oil.
- Thoroughly clean the interior of the boat; vacuum all carpets and dry-clean upholstery.
- Remove cushions
- Open the refrigerator/cooler door and as many locker doors as possible. Leaving as many of these areas open as possible will improve fresh air ventilation during the storage period.
- Place a mildew preventive system in the cabin area before it is closed for storage.
- Clean the exterior upholstery with a good vinyl cleaner, and dry thoroughly. Spray the weather covers and boat upholstery with a spray disinfectant. Enclosed areas such as the refrigerator, shower basin, storage locker areas, etc., should also be sprayed with a disinfectant.

Supporting the Boat for Storage

A trailer, elevating lift, or well-made cradle is the best support for your boat during storage. When storing the boat on a trailer for a long period:

- Make sure the rollers and pads support the hull of the boat and the trailer is on a level surface with the bow high enough so water will drain from the bilge and cockpit. The trailer must properly support

the hull. The bunks and rollers should match the bottom of the hull and should not put pressure on the lifting strakes.

- Make sure the hitch is properly supported.
- Check the tires once each season. Add enough air for the correct amount of inflation for the tires.
- Make sure the engines are in the down position.

Custom-made cradles, with protective padding on the bunks, are available through your Tiara Yachts dealer.

When storing the boat on a lift or cradle:

- The cradle must be specific for boat storage. Make sure the lift or cradle is well-supported with the bow high enough to provide proper drainage of the bilge. The cradle or lift must be in the proper fore and aft position to properly support the hull. When the cradle or lift is in the correct location, the bunks should match the bottom of the hull and should not be putting pressure on the lifting strakes.
- Make sure the engines are in the down position.
- Make sure bunks and rollers are adjusted so they are not putting pressure on the lifting strakes and are providing enough support for the hull. Hull damage resulting from improper cradle or trailer support is not covered by the Tiara warranty.

12.3 Recommissioning

DO NOT operate the boat unless it is completely assembled. Keep all fasteners tight. Keep adjustments according to specifications.

Before launching the boat, make sure to install hull drain plug(s).

Recommissioning the boat after storage:

- Charge and install the batteries.

- Install hull drain plug(s).
- Check the bilge area and all thru-hulls and seacocks to ensure there are no leaks.
- Open all seacocks and make sure the hoses and fittings are not leaking.
- Verify all bilge pumps are operational by manually activating the float switch at each pump.
- Check the engines and generator for damage and follow the manufacturer's instructions for recommissioning.
- Check the mounting bolts of engines to make sure they are tight.
- Perform all routine maintenance.
- Check all hose clamps for tightness.
- Pump antifreeze from any systems winterized with antifreeze and flush several times with fresh water. Make sure all antifreeze is flushed from the water heater (if installed) and it is filled with fresh water before it is activated. Disinfect the fresh water system. Refer to section 5, Plumbing Systems, for instructions.
- Check and lubricate the steering system.
- Clean and wash the boat.
- Install all upholstery, cushions, and canvas.

After launching:

- Check all water systems and the engine mounting bolts for leaks. Operate each system one at a time and check for leaks and proper operation.
- Make sure all BILGE pump switches are ON.
- When the engines start, check the cooling system port below the engine cowling for a strong stream of water to ensure cooling pump is operating.
- Carefully monitor the gauges and check for leakage and abnormal noises.
- Operate the boat at slow speeds until the engine temperature stabilizes and all systems are operating normally.

Aft: In, near, or toward the stern of a boat.

Aground: A boat stuck on the bottom.

Amidships: In or toward the part of a boat midway between the bow and stern.

Anchor: A specially shaped heavy metal device designed to dig efficiently into the bottom under a body of water and hold a boat in place.

Anchor locker: a locker, usually located in the bow of a boat, used for stowing the anchor line or chain

Anchorage: An area specifically designated by governmental authorities in which boats may anchor.

Ashore: On shore.

Astern: Behind the boat, to move backwards.

Athwartship: At right angles to the center line of the boat.

Barnacles: Small, hard-shelled marine animals which are found in salt water attached to pilings, docks and bottoms of boats.

Beam: The breadth of a boat usually measured at its widest part.

Beamy: boats of greater than normal beam

Bearing: The direction of an object from the boat, either relative to the boat's direction or to compass degrees.

Berth: A bunk or a bed on a boat.

Bilge: The bottom of the boat below the flooring.

Bilge Pump: A pump that removes water that collects in the bilge.

Boarding: Entering or climbing into a boat.

Boarding Ladder: Set of steps temporarily fitted over the side of a boat to assist persons coming aboard.

Boat Hook: Short shaft of wood or metal with a hook fitting at one end shaped to aid in extending one's reach from the side of the boat.

Bow: The front end of a boat's hull.

Bow Line: A line that leads forward from the bow of the boat.

Bow Rail: Knee high rails of solid tubing to aid in preventing people from falling overboard.

Bridge: The area from which a boat is steered and controlled.

Bridge Deck: A deck forward and usually above the cockpit deck.

Broach: When the boat is sideways to the seas and in danger of capsizing; a very dangerous situation that should be avoided.

Bulkhead: Vertical partition or wall separating compartments of a boat.

Cabin: Enclosed superstructure above the main deck level.

Capsize: When a boat lays on its side or turns over.

Chapman's: Chapman Piloting & Seamanship, by Chapman and Jonathon Eaton; published by Hearst.

Chain locker: See anchor locker.

Chock: A deck fitting, usually of metal, with inward curving arms through which mooring or anchor lines are passed so as to lead them in the proper direction both onboard and off the boat.

Cleat: A deck fitting, usually of metal with projecting arms used for securing anchor and mooring lines.

Closed Cooling System: A separate supply of fresh water that is used to cool the engine and circulates only within the engine.

Coaming: A vertical piece around the edges of cockpit, hatches, etc., to stop water on deck from running below.

Cockpit: An open space, usually in the aft deck, outside of the cabin.

Companionway: Opening in the deck of a boat to provide access below.

Compartment: The interior of a boat divided off by bulkheads.

Cradle: A framework designed to support a boat as she is hauled out or stored.

Cutlass Bearing: A rubber bearing in the strut that supports the propeller shaft.

Deck: The floor-like platform of a boat that covers the hull.

Displacement: The volume of water displaced by the hull. The displacement weight is the weight of this volume of water.

Draft: The depth of water a boat needs to float.

Drydock: A dock that can be pumped dry during boat construction or repair.

Dry Rot: A fungus attack on wood areas.

Electrical Ground: A connection between an electrical connector and the earth.

Engine Beds: Sturdy structural members running fore and aft on which the inboard engines are mounted.

EPIRB: Emergency Position Indicating Radio Beacon. Operates as a part of a worldwide satellite distress system.

Even Keel: When a boat floats properly as designed.

Fathom: A measure of depth. One Fathom = 6 feet.

Fender: A soft object of rubber or plastic used to protect the topsides from scarring and rubbing against a dock or another vessel.

Fend off: To push or hold the boat off from the dock or another boat.

Flying Bridge: A control station above the level of the deck or cabin.

Flukes: The broad portions of an anchor which dig into the ground.

Following Sea: A sea that comes up from the stern and runs in the same direction that the boat is going.

Fore: Applies to the forward portions of a boat near the bow.

Foundering: When a boat fills with water and sinks.

Fuel pump: feeds fuel under pressure

Freeboard: The height from the waterline to the lowest part of the deck.

Galley: The kitchen of a boat.

Grab Rail: Hand-hold fittings mounted on cabin tops or sides for personal safety when moving around the boat, both on deck and below.

Ground Tackle: A general term including anchors, lines, and other gear used in anchoring.

Grounds: A boat touches the bottom.

Gunwale: The upper edge of a boat's side.

Hand Rail: Rail mounted on the boat, for grabbing with your hand, to steady you while walking about the boat.

Harbor: An anchorage which provides reasonably good protection for a boat, with shelter from wind and sea.

Hatch: An opening in the deck with a door or lid to allow for access down into a compartment of a boat.

Head: A toilet on a boat.

Heat Exchanger: Used to transfer the heat that is picked up by the closed cooling system to the raw cooling water.

Helm: The steering and control area of a boat.

Hull: The part of the boat from the deck down.

Inboard: A boat with the engine mounted within the hull of the boat. Also refers to the center of the boat away from the sides.

Inboard/outboard: Also stern drive or I/O. A boat with an inboard engine attached to an outboard drive unit.

Keel: A plate or timber plate running lengthwise along the center of the bottom of a boat.

Knot: Unit of speed indicating nautical miles per hour. 1 knot = 1 nautical mile per hour (1.15 miles per hour). A nautical mile is equal to one minute of latitude: 6076 feet. Knots times 1.15 equals miles per hour. Miles per hour times .87 equals knots.

Lay-up: To decommission a boat for the winter (usually in northern climates).

Leeward: The direction toward which the wind is blowing.

Length On The Waterline (LWL): A length measurement of a boat at the waterline from the stern to where the hull breaks the water near the bow.

Length Overall (LOA): a length measurement of a boat from the fore part of the stem to the after part of the stern

Life Preserver: provides additional buoyancy to keep a person afloat when he/she is in the water

Limber Hole: A passage cut into the lower edges of floors and frames next to the keel to allow bilge water to flow to the lowest point of the hull where it can be pumped overboard.

Line: The term used to describe a rope when it is on a boat.

Lists: A boat that inclines to port or starboard while afloat.

Locker: A closet, chest or box aboard a boat.

Loran: An electronic navigational instrument which monitors the boat's position using signals emitted from pairs of transmitting stations.

Lunch hook: A small light weight anchor typically used instead of the working anchor. Normally used in calm waters with the boat attended.

Marina: A protected facility primarily for recreational small craft.

Marine Ways or Railways: Inclined planes at the water's edge onto which boats are hauled.

Midships: The center of the boat.

Moored: A boat secured with cables, lines or anchors.

Mooring: An anchor permanently embedded in the bottom of a harbor that is used to secure a boat.

Nautical Mile: A unit of measure equal to one minute of latitude. (6076 feet)

Nun Buoy: A red or red-striped buoy of conical shape.

Oil Pump: Supplies lubricating oil where needed within the engine.

Outboard: A boat designed for an engine to be mounted on the transom. Also a term that refers to objects away from the center line or beyond the hull sides of a boat.

Overhead: the ceiling of a cabin or compartment,

Pad Eye: A deck fitting consisting of a metal eye permanently secured to the boat.

Personal Flotation Device (PFD): For example, a life preserver or throwable device.

Pier: A structure which projects out from the shoreline.

Pile or Piling: A long column driven into the bottom to which a boat can be tied.

Pitch: The measure of the angle of a propeller blade. Refers to the theoretical distance the boat travels with each revolution of the propeller.

Pitching: The fore and aft rocking motion of a boat as the bow rises and falls.

Plenum: a chamber for directing air flow, as in engine intake air plenum

Port: The left side of the boat when facing the bow.

Porthole (port): The opening in the side of a boat to allow the admittance of light and air.

Propeller: A device having two or more blades that is attached to the engine and used for propelling a boat.

Propeller Shaft: Shaft which runs from the back of the engine gear box, aft, through the stuffing box, shaft log, struts, and onto which the propeller is attached.

Pyrotechnic Distress Signals: Distress signals that resemble the brilliant display of flares or fireworks.

Raw Water Cooled: Refers to an engine cooling system that draws sea water in through a hull fitting or engine drive unit, circulates the water in the engine, and then discharges it overboard.

Reduction Gear: Often combined with the reverse gear so that the propeller turns at a slower rate than the engine.

Reverse Gear: Changes the direction of rotation of the propeller to provide thrust in the opposite direction for stopping the boat or giving it stern-way.

Roll: A boat's sideways rotational motion in rough water.

Rope Locker: See anchor locker.

Rubrail: Railing (often rubber or hard plastic) that runs along the boat's sheer to protect the hull when coming alongside docks, piers, or other boats.

Rudder: A movable flat surface that is attached vertically at or near the stern for steering.

Sea anchor: An anchor that does not touch the bottom. Provides drag to hold the bow in the most favorable position in heavy seas.

Scupper: An opening in the hull side or transom of the boat through which water on deck or in the cockpit is drained overboard.

Seacock: Safety valves installed just inside the thru-hull fittings and ahead of the piping or hose running from the fittings.

Shaft Log: Pipe through which the propeller shaft passes.

Sheer: The uppermost edge of the hull.

Sling: A strap which will hold the boat securely while being lifted, lowered, or carried.

Slip: A boat's berth between two pilings or piers.

Sole: The deck of a cockpit or interior cabin.

Spring Line: A line that leads from the bow aft or from the stern forward to prevent the boat from moving ahead or astern.

Starboard: The right side of a boat when facing the bow.

Steerageway: Sufficient speed to keep the boat responding to the rudder or drive unit.

Stem: The vertical portion of the hull at the bow.

Stern: The rear end of a boat.

Stern line: a line that leads aft from the stern of the boat

Stow: To pack away neatly.

Stringer: Longitudinal members fastened inside the hull for additional structural strength.

Strut: Mounted to the hull which supports the propeller shaft in place.

Strut Bearing: See "cutlass bearing."

Stuffing Box: Prevents water from entering at the point where the propeller shaft passes through the shaft log.

Superstructure: Something built above the main deck level.

Swamps: When a boat fills with water from over the side.

Swimming Ladder: Much the same as the boarding ladder except that it extends down into the water.

Taffrail: Rail around the rear of the cockpit.

Thru-hull: A fitting used to pass fluids (usually water) through the hull surface, either above or below the waterline.

Topsides: The side skin of a boat between the waterline or chine and deck.

Transom: A flat stern at right angles to the keel.

Travel Lift: A machine used at boat yards to hoist boats out of and back into the water.

Trim: Refers to the boat's angle or the way it is balanced.

Trough: The area of water between the crests of waves and parallel to them.

Twin-Screw Craft: A boat with two propellers on two separate shafts.

Underway: When a boat moves through the water.

Wake: Disrupted water that a boat leaves astern as a result of its motion.

Wash: The flow of water that results from the action of the propeller or propellers.

Waterline: The plane of a boat where the surface of the water touches the hull when it is afloat on even keel.

Water pump: circulates cooling water

Watertight Bulkhead: Bulkheads secured so tightly so as not to let water pass.

Wharf: A structure generally parallel to the shore.

Windlass: A winch used to raise and lower the anchor.

Windward: Toward the direction from which the wind is coming.

Working Anchor: An anchor carried on a boat for most normal uses. Refers to the anchor used in typical anchoring situations.

Yacht Basin: A protected facility primarily for recreational small craft.

Yaw: Side-to-side movement, usually caused by rough seas.

Owner's Guide: Care & Upkeep of Fiberglass Products

As the world's premier gel coat supplier, Polynt Composites has provided this brochure as a guide to properly maintain and care for your gel coat surface.

Gel Coats provide a protective layer against weathering on a surface. Over time, exposure to sunlight, water, dust and chemicals cause wear and tear on the gel coat surface. This results in chalking, discoloration, yellowing or loss of gloss. By following simple, regular maintenance procedures, you can minimize these effects.

Basic Maintenance

When not in use, keep the gel coat surface out of the sun or covered with a canvas tarp. Do not use plastic sheeting or other non-porous materials as they trap moisture between the cover and the surface, causing damage to the gel coat.

For best results, use a cleaner recommended for use with fiberglass and follow label instructions. Alternatively, you can wash the surface with a mild detergent, such as dishwashing soap.

DO NOT use automatic dishwasher detergent, abrasive cleaners, bleach, strong acids or bases (i.e. TSP or ammonia). Only use pH neutral cleaners.

Wax at least twice a year to restore gloss and protect the finish. Only use a wax that is recommended for gel coat surfaces and follow instructions carefully. NEVER wax a gel coat surface in direct sunlight.

Corrective Procedures*

Chalking

A fine rubbing compound as well as a mild detergent will reduce the weathering and chalking accumulated on the surface. Use only a fine grit compound and follow label directions carefully. DO NOT apply rubbing compound in direct sunlight. For best results, wax after applying compound. When applying wax, remove excess compound and apply a thin layer of wax using a clean cloth. It is recommended to use a wax designed for fiberglass.

Scratches, Nicks and Stains

Most scratches and nicks can be removed by using a rubbing compound followed by waxing as described above. Deep marks or gouges should be professionally repaired.

Most stains can be removed by washing with mild detergent. For stubborn stains, use a fine abrasive household cleanser designed for fiberglass products, followed by waxing to restore its original luster.

Non-water soluble stains such as grease and oil, rubber heel marks, etc., can be removed by using a solvent such as acetone, rubbing alcohol, toluene or xylene, followed by a mild detergent. If these solvents are not effective, try a rubbing compound or fine sanding followed by a rubbing compound and then waxing.

If you have questions, consult your local dealer.



Polynt Composites USA
99 E. Cottage Ave
Carpentersville, IL 60110

800-322-8103

**Always try a test spot first*



Operator Notes

Lined area for notes, consisting of multiple horizontal lines.

Maintenance	Each Use	Weekly	Monthly	Semi Annually	Yearly	As Needed
Clean hull below the waterline				X		
Bottom paint					X	X
Check sacrificial anodes			X			
Replace sacrificial anodes					X	
Wash boat canvas & hardware	X		X			
Wax exterior gelcoat				X		X
Clean & protect hardware						X
Polish & protect plastic glass					X	X
Clean exterior upholstery	X					X
Clean cabin & interior upholstery						X
Flush engine with fresh water	X					
Spray metal components in bilge with a protector			X			
Clean bilge				X		X
Check bilge for leaks	X		X			
Inspect & operate thru-hull valves			X			
Inspect steering & control systems	X					
Service steering & control systems				X		
Inspect fuel system for leaks	X					
Inspect & service fuel system				X		
Inspect fuel tank vents & screens					X	
Replace fuel filters					X	
Lubricate fuel fill o-rings			X			
Inspect fire extinguisher			X			
Test bilge pump auto switches	X					
Inspect & protect electrical components, wire & battery connections				X		
Check battery electrolyte & service			X			
Test and inspect AC electrical system & shore power cord				X		
Inspect water systems for leaks				X		
Check neutral safety switch	X					
Check trim tab fluid level			X			

DEPARTMENT OF HOMELAND SECURITY U.S. Coast Guard RECREATIONAL BOATING ACCIDENT REPORT		OMB Control Number: 1625-0003 Expires: 07/31/2022
INSTRUCTIONS: Use "Report required because" section below to determine if a report is required for your accident. If required, please have each vessel owner or operator involved in the accident submit a report to their state reporting authority. Each boat operator/owner involved in an accident should submit a separate report. For each question below, please provide answers if applicable and if known; otherwise leave blank.		
Privacy Act Notice		
Authority: 46 U.S.C. 6102 and 33 CFR 173 & 174 authorize the collection of information on boating accidents. Purpose: The Coast Guard uses this information for statistical purposes, chiefly to inform the public, to measure the Program's efforts, and to regulate issues relating to boating safety. Routine Uses: The Coast Guard shares this information within the agency, and if state and federal law permit it, to the public.		
REPORT SUBMISSION		
Report required because (select all that apply): <input type="checkbox"/> At least one person in this accident <i>died</i> . If so, how many? <input style="width: 50px;" type="text"/> <input type="checkbox"/> At least one injured person in this accident <i>required or was in need of treatment beyond first aid</i> . If so, how many? <input style="width: 50px;" type="text"/> <input type="checkbox"/> At least one person in this accident <i>disappeared</i> and has not yet been recovered. If so, how many? <input style="width: 50px;" type="text"/> <input type="checkbox"/> All boat and other property damage (e.g., fishing/hunting gear) caused by this accident <i>totaled (or likely totaled) \$2,000 or more</i> : Approximate value of damage to <i>your</i> boat: \$ <input style="width: 50px;" type="text"/> Approximate value of damage to <i>your</i> other property: \$ <input style="width: 50px;" type="text"/> <input type="checkbox"/> Your or another <i>boat</i> in this accident was (or likely was) a <i>total loss</i>		To be submitted within: 48 hours (if injury, disappearance or death) 10 days (if boat/property damage only) To be submitted to: (Local State Reporting Authority) Phone: You may submit any comments concerning the accuracy of the burden estimate or any suggestions for reducing the burden to: Commandant (CG-BSX-21), U.S. Coast Guard, Washington, DC 20593-0001 or Office of Management and Budget, Paperwork Reduction Project (1625-0003), Washington, DC 20503. Questions relating to the collection of this data should be sent to the Coast Guard.
Report submitted by (select all that apply): <input type="checkbox"/> Boat Operator (required if possible) <input type="checkbox"/> Boat Owner (if operator unable, or same as operator) <input type="checkbox"/> Other (describe): <input style="width: 100%;" type="text"/>		For State Agency Use Only
First Name	Last Name	Phone
		First Name <input style="width: 100%;" type="text"/> Last Name <input style="width: 100%;" type="text"/> Phone: <input style="width: 100%;" type="text"/> Primary Cause of Accident <input style="width: 100%;" type="text"/>
ACCIDENT SUMMARY		
WHEN Date: <input style="width: 100px;" type="text"/> Time: <input type="checkbox"/> am <input type="checkbox"/> pm <input type="checkbox"/> (mm/dd/yyyy) (select one)		ACCIDENT DESCRIPTION: Briefly describe this accident (attach extra pages if necessary)
WHERE Body of Water Name <input style="width: 100%;" type="text"/>		
Location (on water) description <input style="width: 100%;" type="text"/> Nearest city/town <input style="width: 100%;" type="text"/> County: <input style="width: 100px;" type="text"/> State: <input style="width: 50px;" type="text"/>		DAMAGE TO YOUR BOAT: Briefly summarize any damage to your boat
YOUR BOAT – PEOPLE		
# people on board (including operator): <input style="width: 100px;" type="text"/>		DAMAGE TO YOUR OTHER PROPERTY: (NOT BOAT) Briefly summarize any damage to your other property (not boat)
# people being towed (e.g., on tubes, skis): <input style="width: 100px;" type="text"/>		
# people wearing lifejackets (on board or towed): <input style="width: 100px;" type="text"/>		
OTHER BOATS INVOLVED IN ACCIDENT		
# of other boats involved: <input style="width: 100px;" type="text"/>		

For each question below, please provide answers IF APPLICABLE AND IF KNOWN, otherwise leave blank.														
YOUR BOAT														
BOAT IDENTIFICATION														
Your Boat Name:						Manufacturer:								
Model Name:						Model Year:								
Registration #:						Documentation #:								
Hull Identification # (HIN):						Rented: <input type="checkbox"/> Yes <input type="checkbox"/> No								
SIZE ESTIMATES														
Length: ft.		Depth from transom (stern) to keel (bottommost point): ft.				in.		Beam width at widest point: ft.						
HULL MATERIAL														
Type of Hull Material (select one)														
Fiberglass			Wood			Rubber/vinyl/canvas			Other (describe):					
Aluminum			Steel			Plastic								
BOAT TYPE														
Boat Type (select one)						Available Propulsion (select all that apply)								
Cabin motorboat		Inflatable boat		Personal watercraft (PWC) (e.g., Wave Runner™, Jet Ski™, Sea-Doo™)		Paddlecraft:		Propeller		Air thrust				
Open motorboat		Houseboat				Canoe		Sail		Other (describe):				
Auxiliary sail		Sail (only)		Air boat		Kayak		Manual						
Pontoon boat		Rowboat		Other (describe):				Water jet						
ENGINE														
# Engines:			Engine type and horsepower (select one)						Fuel type (select all that apply)					
Manufacturer			Outboard		Sterndrive		Inboard		Pod drive		Gas		Electric	
Total horsepower: hp			No engine		Other:				Diesel		Other:			
SAFETY MEASURES														
Organizations that have conducted a vessel safety check (VSC) on board your boat within the past year (including carriage of safety equipment, e.g., lifejackets, anchor and line, fire extinguishers):														
US Coast Guard Auxiliary: VSC Decal? <input type="checkbox"/> Yes <input type="checkbox"/> No				Federal Agency (Name):										
US Power Squadrons: VSC Decal? <input type="checkbox"/> Yes <input type="checkbox"/> No				State Agency (Name):										
				Other Agency (Name):										
# Life jackets on board:		# Fire extinguishers on board:		Type of fire extinguishers (e.g., ABC):										
		# Fire extinguishers used:												
ACCIDENT DETAILS – EXTERNAL CONDITIONS														
WEATHER														
Overall weather was (select one)				It was (select one)		Visibility was (select one)			Wind was (select one)					
Clear		Raining		Day		Good			0 mph (none)					
Cloudy		Snowing		Night		Fair			Over 0, up to 12 mph (light)					
Foggy		Hazy				Poor			Over 12, up to 25 mph (moderate)					
Other (describe):				Approximate air temperature:		°F			Over 25, up to 55 mph (strong)					
									Over 55 mph (stormy)					
WATER														
Overall water conditions (select one):						Other water conditions:								
Up to 6 in. waves (calm)						Approximate water temperature:			°F					
Over 6 in., up to 2 ft. waves (choppy)						Strong current?			Yes		No			
Over 2 ft., up to 6 ft. waves (rough)						Hazardous waters? (e.g., rapid tidal flow, currents)			Yes		No			
Over 6 ft. waves (very rough)						Congested waters?			Yes		No			

For each question below, please provide answers IF APPLICABLE AND IF KNOWN, otherwise leave blank.			
ACCIDENT DETAILS – ACTIVITIES AND OPERATIONS ON YOUR BOAT			
OPERATOR/PASSENGER ACTIVITIES			
Operator/passenger activities on <i>your</i> boat at time of accident:			
Activities were (select one)		Operator/Passenger activities (select all that apply)	
<input type="checkbox"/> Recreational	<input type="checkbox"/> Fishing	<input type="checkbox"/> Tubing	<input type="checkbox"/> Starting engine
<input type="checkbox"/> Commercial	<input type="checkbox"/> Hunting	<input type="checkbox"/> Water Skiing	<input type="checkbox"/> Making repairs
	<input type="checkbox"/> White water activity (e.g., rafting)	<input type="checkbox"/> Relaxing	<input type="checkbox"/> Other (list):
BOAT OPERATIONS			
Your boat operations at time of accident (select all that apply)			
<input type="checkbox"/> Cruising (underway under power)	<input type="checkbox"/> Drifting	<input type="checkbox"/> Racing	<input type="checkbox"/> Towing another vessel
<input type="checkbox"/> Changing direction	<input type="checkbox"/> At anchor	<input type="checkbox"/> Rowing/paddling	<input type="checkbox"/> Launching
<input type="checkbox"/> Changing speed	<input type="checkbox"/> Being towed	<input type="checkbox"/> Docking/undocking	<input type="checkbox"/> Tied to dock/mooring
<input type="checkbox"/> Sailing	<input type="checkbox"/> Other (list):		
ACCIDENT DETAILS – CONTRIBUTING FACTORS ON YOUR BOAT			
CONTRIBUTING FACTORS			
Indicate factors on <i>your</i> boat which may have contributed to this accident (select all that apply)			
<input type="checkbox"/> Alcohol use	<input type="checkbox"/> Improper lookout	<input type="checkbox"/> Dam/lock	<input type="checkbox"/> Starting in gear
<input type="checkbox"/> Drug use	<input type="checkbox"/> Operator inattention	<input type="checkbox"/> Force of wake/wave	<input type="checkbox"/> Sharp turn
<input type="checkbox"/> Excessive speed	<input type="checkbox"/> Operator inexperience	<input type="checkbox"/> Hazardous waters	<input type="checkbox"/> Restricted vision (e.g., fog)
<input type="checkbox"/> Improper anchoring	<input type="checkbox"/> Language barrier	<input type="checkbox"/> Heavy weather	<input type="checkbox"/> Mission/inadequate aids to navigation (e.g., buoy, daymarker)
<input type="checkbox"/> Improper loading	<input type="checkbox"/> Navigation rules violation	<input type="checkbox"/> Ignition of fuel or vapor	<input type="checkbox"/> Inadequate on-board navigation lights
<input type="checkbox"/> Overloading	<input type="checkbox"/> Failure to vent	<input type="checkbox"/> Hull failure	<input type="checkbox"/> People on gunwale, bow or transom
<input type="checkbox"/> Other (describe):			
ACCIDENT DETAILS – YOUR BOAT			
MACHINERY/EQUIPMENT FAILURE			
Failure of the following machinery/equipment on <i>your</i> boat contributed to this accident (select all that apply)			
<input type="checkbox"/> Engine	<input type="checkbox"/> Onboard lights	<input type="checkbox"/> Shift	<input type="checkbox"/> Sound equipment (e.g., horn, whistle)
<input type="checkbox"/> Electrical system	<input type="checkbox"/> Seats	<input type="checkbox"/> Radio	<input type="checkbox"/> Auxiliary equipment
<input type="checkbox"/> Fuel system	<input type="checkbox"/> Steering	<input type="checkbox"/> Fire extinguisher	<input type="checkbox"/> Other (list):
<input type="checkbox"/> Sail/mast	<input type="checkbox"/> Throttle	<input type="checkbox"/> Ventilation	
<input type="checkbox"/> Onboard navigation aids (e.g., GPS)			
ACCIDENT DETAILS – EVENTS ON YOUR BOAT			
ACCIDENT EVENTS			
Types of events occurring to/on <i>your</i> boat during accident (select all that apply)			
<input type="checkbox"/> Collision with recreational boat	<input type="checkbox"/> Flooding/swamping	<input type="checkbox"/> Person fell overboard	
<input type="checkbox"/> Collision with commercial boat (e.g., tug, barge)	<input type="checkbox"/> Fire/explosion – fuel	<input type="checkbox"/> Person fell on/within boat	
<input type="checkbox"/> Collision with fixed object (e.g., dock, bridge)	<input type="checkbox"/> Fire/explosion – non-fuel	<input type="checkbox"/> Sudden medical condition	
<input type="checkbox"/> Collision with submerged object (e.g., stump, cable)	<input type="checkbox"/> Carbon monoxide exposure	<input type="checkbox"/> Person struck by boat	
<input type="checkbox"/> Collision with floating object (e.g., log, buoy)	<input type="checkbox"/> Mishap of skier, tuber, wake boarder, etc.	<input type="checkbox"/> Person struck by propeller or propulsion unit	
<input type="checkbox"/> Capsizing	<input type="checkbox"/> Person left boat voluntarily	<input type="checkbox"/> Person electrocuted	
<input type="checkbox"/> Grounding	<input type="checkbox"/> Person ejected from boat (caused by collision or maneuver)		
<input type="checkbox"/> Sinking	<input type="checkbox"/> Other (describe):		

For each question below, please provide answers IF APPLICABLE AND IF KNOWN, otherwise leave blank.									
ACCIDENT DETAILS – YOUR BOAT- INJURED PEOPLE RECEIVING OR IN NEED OF TREATMENT BEYOND FIRST AID									
<i>Report only injured people on, struck by, or being towed by your boat, receiving or in need of treatment beyond first aid. Do not report injured people on, struck by, or being towed by another boat or no boat (e.g., swimmers, people on a dock). If more than one injured person to report, attach additional copies of this page. If none, SKIP INJURED PEOPLE section.</i>									
INJURED PERSON									
First Name			MI		Last Name				
Street									
City			State			Zip			
Phone			Date of Birth (mm/dd/yyyy)			Age			
INJURY DETAILS									
Injury caused when person (select all that apply)					Nature of most serious injury (select one)				
Struck the (e.g., boat, water):					Scrape/bruise		Dislocation		
Was struck by a (e.g., boat, propeller):					Cut		Internal organ injury		
Was exposed to carbon monoxide poisoning					Sprain/strain		Amputation		
Received an electric shock					Concussion/brain injury		Burn		
Other (describe):					Spinal cord injury		Other (describe):		
Person was wearing lifejacket?			Yes		No		Broken/fractured bone		
Person received treatment beyond first aid?			Yes		No		Body part of most serious injury (e.g., head, trunk, leg):		
Person was admitted to a hospital?			Yes		No				
ACCIDENT DETAILS – YOUR BOAT – DEATHS/DISAPPEARANCES									
<i>Only report deaths/disappearances of people on, struck by, or being towed by your boat. If more than one death/disappearance to report, attach additional copies of this page. If none, SKIP DEATHS/DISAPPEARANCES section.</i>									
PERSON WHO DIED/DISAPPEARED									
First Name			MI		Last Name				
Street									
City			State			Zip			
Phone			Date of Birth (mm/dd/yyyy)			Age			
DETAILS OF DEATH/DISAPPEARANCE									
Injury caused when person (select all that apply)					Nature of death/disappearance (select one)				
Struck the (e.g., boat, water):					Death – by drowning				
Was struck by a (e.g., boat, propeller):					Death – other likely cause (describe)				
Was exposed to carbon monoxide poisoning									
Received an electric shock					Disappeared and not yet recovered				
Other (describe):					Person was wearing lifejacket?		Yes		No

For each question below, please provide answers IF APPLICABLE AND IF KNOWN, otherwise leave blank.							
ACCIDENT DETAILS – YOUR BOAT OPERATOR							
OPERATOR INSTRUCTION				OPERATOR SAFETY MEASURES			
Boating safety instruction completed <i>(select all that apply)</i>				On board, prior to accident, was operator wearing:			
None				A lifejacket?		Yes	No
State course				An engine cut-off switch <i>(Lanyard or wireless device)</i> if equipped?		Yes	No
USCG Auxiliary course				On board, prior to accident, was operator using:			
US Power Squadrons course				Alcohol?		Yes	No
Internet <i>(name of sponsoring organization)</i>				Drugs?		Yes	No
Other <i>(describe)</i>				Operator arrested for Boating Under the Influence?		Yes	No
				Weather reports consulted prior to accident?		Yes	No
OPERATOR EXPERIENCE							
Experience operating this type of boat <i>(select one)</i>							
0 to 10 hours		Over 10, up to 100 hours		Over 100, up to 500 hours		Over 500 hours	
ACCIDENT DETAILS – OTHER KEY PEOPLE							
Only report other key people not already documented as injured, died, disappeared or operator/owner of your boat. If more than two other key people to report, attach additional copies of this page.							
NAME/ADDRESS							
This other key person was a(n) <i>(select all that apply)</i>							
<input type="checkbox"/> Other boat operator <input type="checkbox"/> Other boat owner <input type="checkbox"/> Owner of other damaged property <input type="checkbox"/> Passenger on your boat <input type="checkbox"/> Witness							
First Name			MI	Last Name			
Street							
City			State	Zip	Phone		
Other boat name <i>(if any)</i>				Other boat registration # <i>(if any)</i>			
NAME/ADDRESS							
This other key person was a(n) <i>(select all that apply)</i>							
<input type="checkbox"/> Other boat operator <input type="checkbox"/> Other boat owner <input type="checkbox"/> Owner of other damaged property <input type="checkbox"/> Passenger on your boat <input type="checkbox"/> Witness							
First Name			MI	Last Name			
Street							
City			State	Zip	Phone		
Other boat name <i>(if any)</i>				Other boat registration # <i>(if any)</i>			

For each question below, please provide answers IF APPLICABLE AND IF KNOWN, otherwise leave blank.					
YOUR BOAT OPERATOR					
NAME/ADDRESS					
First Name	MI	Last Name			
Street					
City	State	Zip			
AGE/GENDER/PHONE					
Date of Birth (mm/dd/yyyy)	Age	Gender	Male	Female	Phone
YOUR BOAT OWNER					
If same as <i>your boat operator</i> SKIP rest of YOUR BOAT OWNER section.					
NAME/ADDRESS/PHONE					
First Name	MI	Last Name			
Street					
City	State	Zip	Phone		
PERSON SUBMITTING THIS REPORT					
If same as <i>your boat operator</i> OR <i>owner</i> , SKIP rest of PERSON SUBMITTING THIS REPORT section.					
NAME/ADDRESS/PHONE/ROLE					
First Name	MI	Last Name			
Street					
City	State	Zip	Phone		
I was a(n) (select one)					
<input type="checkbox"/>	Other person on board <i>this</i> boat				
<input type="checkbox"/>	Accident witness <i>not</i> on board <i>this</i> boat				
<input type="checkbox"/>	Other (<i>describe</i>):				
SIGNATURE OF PERSON SUBMITTING THIS REPORT					
Your signature				Date (mm/dd/yyyy)	
<p>An Agency may not conduct or sponsor and a person is not required to respond to an information collection, unless it displays a currently valid OMB Control Number.</p> <p>The Coast Guard estimates that the average burden for this report form is 30 minutes. You may submit any comments concerning the accuracy of this burden estimate or any suggestions for reducing the burden to: Commandant (CG-BSX-21), U.S. Coast Guard, Washington, DC 20593-0001 or Office of Management and Budget, Paperwork Reduction Project (1625-0003), Washington, DC 20503.</p>					



www.cgaux.org

FLOAT PLAN

INSTRUCTIONS: Complete this plan before you go boating and leave it with a reliable person who can be depended upon to notify the Coast Guard, or other rescue agency, should you not return or check-in as planned. If you have a change of plans, or will be delayed, notify the person holding your Float Plan. Finally, close your plan by notifying the holder you have arrived home safely and if the holder has reported you overdue, notify all applicable rescue authorities of your safe return.



www.uscgboating.org

Do NOT file this plan with the Coast Guard

VESSEL

IDENTIFICATION:

Name & Hailing Port _____
 Document / Registration No. _____ HIN _____
 Year, Make & Model _____
 Length _____ Type _____ Draft _____ Hull Mat. _____
 Hull & Trim Colors _____
 Prominent Features _____

COMMUNICATION:

Radio Call Sign / Number _____
 DSC MMSI No. _____
 Radio-1: Type _____ Ch. / Freq. Monitored _____
 Radio-2: Type _____ Ch. / Freq. Monitored _____
 Cell / Satellite _____
 Email _____

PROPULSION:

Primary-- Type _____ Eng. _____ Fuel Capacity _____
 Auxiliary--Type _____ Eng. _____ Fuel Capacity _____

NAVIGATION: (Check all onboard)

Compass Radar GPS / DGPS Depth Sounder
 Charts Maps _____

SAFETY & SURVIVAL

VISUAL DISTRESS SIGNALS:

Electric Distress Light (night only)
 Flag (day only)
 Flare, Aerial (day & night)
 Flare, Handheld (day & night)
 Signal Mirror (day only)
 Smoke (day only)

AUDIBLE DISTRESS SIGNALS:

Bell
 Horn
 Whistle

EPIRB:

UIN* _____

ADDITIONAL GEAR:

Anchor - Line length _____ Food for _____ days / person
 Dewatering device Water for _____ days / person
 Exposure suits _____
 Fire Extinguisher _____
 Flashlight / Searchlight _____
 Raft / Dinghy _____

PERSONS ONBOARD

OPERATOR:

Name _____
 Address _____
 City _____ State _____ Zip Code _____
 Age _____ Gender _____ PFD PLB UIN* _____
 Note _____
 Float Plan Note _____

Has experience with: this vessel; the boating area(s).
 Home Phone _____
 Vehicle (Year, Make & Model) _____
 Vehicle License No. _____ Trailer
 Vehicle parked at _____

PASSENGERS / CREW: (Identify all on board)

Name	Home Phone	Age	Gender	PFD	Note
1. _____	_____	_____	_____	<input type="checkbox"/>	_____
2. _____	_____	_____	_____	<input type="checkbox"/>	_____
3. _____	_____	_____	_____	<input type="checkbox"/>	_____
4. _____	_____	_____	_____	<input type="checkbox"/>	_____
5. _____	_____	_____	_____	<input type="checkbox"/>	_____
6. _____	_____	_____	_____	<input type="checkbox"/>	_____
7. _____	_____	_____	_____	<input type="checkbox"/>	_____
8. _____	_____	_____	_____	<input type="checkbox"/>	_____
9. _____	_____	_____	_____	<input type="checkbox"/>	_____
10. _____	_____	_____	_____	<input type="checkbox"/>	_____
11. _____	_____	_____	_____	<input type="checkbox"/>	_____
12. _____	_____	_____	_____	<input type="checkbox"/>	_____

Passenger PLB UIN*
 (Not listed in a specific order)

If you have a genuine concern for the safety or welfare of the persons onboard this vessel that have not returned or checked-in, in a reasonable amount of time, then follow the step-by-step instructions on the Boating Emergency Guide™ located on the last page of this Float Plan.

(*) EPIRB and PLB registration required by Federal regulations. www.beaconregistration.noaa.gov



www.cgaux.org

FLOAT PLAN continued

INSTRUCTIONS: Complete this plan before you go boating and leave it with a reliable person who can be depended upon to notify the Coast Guard, or other rescue agency, should you not return or check-in as planned. If you have a change of plans, or will be delayed, notify the person holding your Float Plan. Finally, close your plan by notifying the holder you have arrived home safely and if the holder has reported you overdue, notify all applicable rescue authorities of your safe return.

Do NOT file this plan with the U.S. Coast Guard



www.uscgboating.org

CONTACTS

Contact 1 _____ Phone Number _____
 Contact 2 _____ Phone Number _____
 Rescue Authority _____ Phone Number _____

ITINERARY

		DATE	TIME	LOCATION / WAYPOINT	MODE OF TRAVEL	REASON FOR STOP	CHECK-IN TIME
1	Depart						
	Arrive						
2	Depart						
	Arrive						
3	Depart						
	Arrive						
4	Depart						
	Arrive						
5	Depart						
	Arrive						
6	Depart						
	Arrive						
7	Depart						
	Arrive						
8	Depart						
	Arrive						
9	Depart						
	Arrive						
10	Depart						
	Arrive						
11	Depart						
	Arrive						
12	Depart						
	Arrive						
13	Depart						
	Arrive						
14	Depart						
	Arrive						
15	Depart						
	Arrive						
16	Depart						
	Arrive						
17	Depart						
	Arrive						
18	Depart						
	Arrive						
19	Depart						
	Arrive						
20	Depart						
	Arrive						
21	Arrive						

If you have a genuine concern for the safety or welfare of the persons onboard this vessel that have not returned or checked-in, in a reasonable amount of time, then follow the step-by-step instructions on the Boating Emergency Guide™ located on the last page of this Float Plan.

USCG Float Plan - BOATING EMERGENCY GUIDE™

BEFORE YOU BEGIN – This guide is designed to work either with or without a Float Plan. You will need the following items: 1) the Float Plan, if one was given to you; 2) a pen or pencil; 3) a clean sheet of paper or writing tablet; and 4) your local telephone directory.

Step 1: Do you have a genuine concern for the safety or welfare of any persons who have not returned or checked-in, in a reasonable amount of time?

If **yes**, then continue with **Step 2**. Otherwise **STOP** – no further action is required at this time.

Step 2: Were you given a prepared Float Plan by anyone on board the vessel?

If **yes**, then continue with **Step 3**. Otherwise, go to **Step 5**.

Step 3: Locate the Contacts at the top of page 2 on the Float Plan. Call Contact number 1...

IF CONTACT #1	THEN						
Answers phone	Take notes during your conversation. 1. Let the person know you are responding to a late return or check-in by the individuals designated on the Float Plan. 2. Determine if the person you are talking to, or anyone else at that location, has recently had contact with anyone on the vessel, and when and where that contact occurred. 3. Are you still concerned about the safety or welfare of any persons on board the vessel? <table border="1" style="margin-left: 20px;"> <thead> <tr> <th>IF</th> <th>THEN</th> </tr> </thead> <tbody> <tr> <td>Yes</td> <td>Continue with Step 4.</td> </tr> <tr> <td>No</td> <td>STOP. No further action is required.</td> </tr> </tbody> </table>	IF	THEN	Yes	Continue with Step 4 .	No	STOP . No further action is required.
IF	THEN						
Yes	Continue with Step 4 .						
No	STOP . No further action is required.						
Does not answer phone	Continue with Step 4 .						

Step 4: Call Contact number 2...

IF CONTACT #2	THEN						
Answers phone	Take notes during your conversation. 1. Let the person know you are responding to a late return or check-in by the individuals designated on the Float Plan. 2. Determine if the person you are talking to, or anyone else at that location, has recently had contact with anyone on the vessel, and when and where that contact occurred. 3. Are you still concerned about the safety or welfare of any persons on board the vessel? <table border="1" style="margin-left: 20px;"> <thead> <tr> <th>IF</th> <th>THEN</th> </tr> </thead> <tbody> <tr> <td>Yes</td> <td>Continue with Step 6.</td> </tr> <tr> <td>No</td> <td>STOP. No further action is required.</td> </tr> </tbody> </table>	IF	THEN	Yes	Continue with Step 6 .	No	STOP . No further action is required.
IF	THEN						
Yes	Continue with Step 6 .						
No	STOP . No further action is required.						
Does not answer phone	Continue with Step 6 .						

Step 5: Using the checklist below, jot down only what you know about each item:

DO NOT SPECULATE. Incorrect information may mislead Search and Rescue personnel; add to the overall search and rescue time; and adversely affect the outcome.

- Period of time the vessel has been overdue.
- Purpose of the trip or voyage.
- Description of vessel. (Type, size, color, features, etc.)
- Vessel's departure point and destination.
- Places the vessel planned to stop during transit.
- Navigation equipment aboard. (Examples: GPS, radar, compass, sounder, etc.)
- Number of persons aboard. Relevant characteristics such as dependability, reliability, etc.
- Was the vessel initially docked or moored or did a vehicle tow it to a launch point?
- License plate number and description of the tow vehicle and/or the passenger's transport vehicle.
- Communications equipment aboard, including type of radio and frequencies monitored, cellular or satellite telephone numbers of individuals, etc.
- Additional points of contact along the vessel's planned route.
- Operator and/or a passenger/crew member absolutely had to be back at the scheduled return time.
- Call your local Rescue Authority that responds to marine emergencies (Police, Sheriff, Constable, First responder, etc.).

Go to **Step 6-2**.

Step 6:

1. Call the Rescue Authority contact at the top of page 2 on the Float Plan.
2. Tell the dispatcher you are responding to a late return or check-in by the persons on board the vessel.
3. The dispatcher will instruct you from there.

Note: The dispatcher will provide you with the necessary contact or agency connection to get a search and rescue mission started. This puts you in direct contact with the agency conducting the actual search and rescue, eliminating unnecessary middlemen.
The dispatcher will tell you if he/she desires a follow-up call on the outcome of the rescue.

4. Continue with **Step 7**.

Step 7: Be patient... you've done everything you can possibly do for now. It is important to keep the telephone available so emergency personnel can contact you with additional information and/or questions concerning the search and rescue effort.

STOP -- End of Guide

Provided as a courtesy by:

S2 Yachts, Inc.
Holland, MI
(616) 392-7163

Get a Vessel Safety Check before you go boating.



The USCG Float Plan is the official Float Plan of the U.S. Coast Guard and U.S. Coast Guard Auxiliary. For more information visit:

www.floatplancentral.org

Problem	Cause and Solution
Control Systems	
<p>Hydraulic steering is slow to respond and erratic.</p>	<ul style="list-style-type: none"> • Steering system is low on fluid. Fill and bleed system. • Steering system has air in it. Fill and bleed system. • A component in the steering system is binding. Check and adjust or repair binding component. • Engine steering cylinder is binding. Grease spindle.
<p>The boat wanders and will not hold a course at cruise speeds.</p>	<ul style="list-style-type: none"> • There could be air in the steering system. Fill & bleed the system. • The engine steering tab is corroded or out of adjustment. Replace or adjust steering tab. • Engine steering cylinder is binding. Grease spindle.
<p>The engine will not start with the shift control lever in neutral.</p>	<ul style="list-style-type: none"> • The control cable is out of adjustment & not activating the neutral safety cut out switch. • The shift control lever is not in the neutral detent. Try moving the shift lever slightly. • There is a loose wire on the neutral safety switch on the transmission. Inspect wires and repair loose connections. • The starter or ignition switch is bad.
Performance Problems	
<p>Boat is sluggish and has lost speed and RPM.</p>	<ul style="list-style-type: none"> • The boat may be need to have marine growth cleaned from hull and running gear. • Propeller may be damaged & need repair. • Weeds or line around the propeller. Clean propeller. • Boat is overloaded. Reduce load. • Check for excessive water in the bilge. Pump out bilge & find & correct the problem. • The throttle adjustments has changed and the engine is not getting full throttle. Adjust the throttle cable.

Problem	Cause and Solution
<p>The boat vibrates at cruising speeds.</p>	<ul style="list-style-type: none"> • Propeller may be damaged and need repair. • The propeller or propeller shaft is bent. Repair or replace damaged components. • The running gear is fouled by marine growth or rope. Clean running gear. • The engine is not trimmed properly. Trim the engine.
<p>Engine Problems</p>	
<p>The engine is running too hot.</p>	<ul style="list-style-type: none"> • The engine raw water pick-up strainer up is clogged with marine growth. Clean pick-up. • The engine raw water pump impeller is worn or damaged. Repair the pump. • The engine thermostat is faulty and needs to be replaced.
<p>The engine alternator is not charging properly.</p>	<ul style="list-style-type: none"> • The battery cable is loose or corroded. Clean and tighten battery cables. • The alternator is not charging and must be replaced. • The engine battery isolator in the charging system is not working properly. Replace the isolator. • The battery is defective. Replace the battery. • The alternator breaker may be in the OFF position.
<p>The engine suddenly will not operate over 2000 RPM.</p>	<ul style="list-style-type: none"> • The engine emergency system has been activated. The onboard computer has sensed a problem and has limited the RPM to protect the engine. Find & correct the problem. • The tachometer is bad and needs to be replaced.

Problem	Cause and Solution
<p>The engine is loosing RPM. The boat is not overloaded and the hull bottom and running gear are clean and in good condition.</p>	<ul style="list-style-type: none"> • The engine may be having a problem with a sticky anti-siphon valve, located in the fuel line near the fuel tank, that is restricting the fuel flow. Remove & clean or replace the anti-siphon valve. • The remote gasoline fuel filter could be dirty. Inspect and replace the fuel filter. • The primary fuel filter on the engine may be dirty. Inspect and replace the fuel filter. • The electronic engine control system on the engine is malfunctioning. Repair the engine control system. • The fuel injection system on the engine is malfunctioning. Repair the fuel injection system.
<p>Accessory Problems</p>	
<p>The livewell pump runs, but does not pump water.</p>	<ul style="list-style-type: none"> • The strainer on the intake scoop is clogged preventing the water from getting to the pump. Put the boat in reverse to clean the strainer. • There is an air lock in the system. Run the boat above 15 m.p.h. and the pick-up scoop will force the air lock past the pump and prime the system. • The thru-hull valve is not open. Open valve. • The valve in the livewell is not open. Open the valve in the livewell.
<p>The automatic float switch on the bilge pump raises but does not activate the pump.</p>	<ul style="list-style-type: none"> • The in-line fuse near the battery switch has blown. Replace the fuse. • The pump impeller is jammed by debris. Clean pump impeller housing. • The pump is defective. Replace pump.

SEVEN MARINE

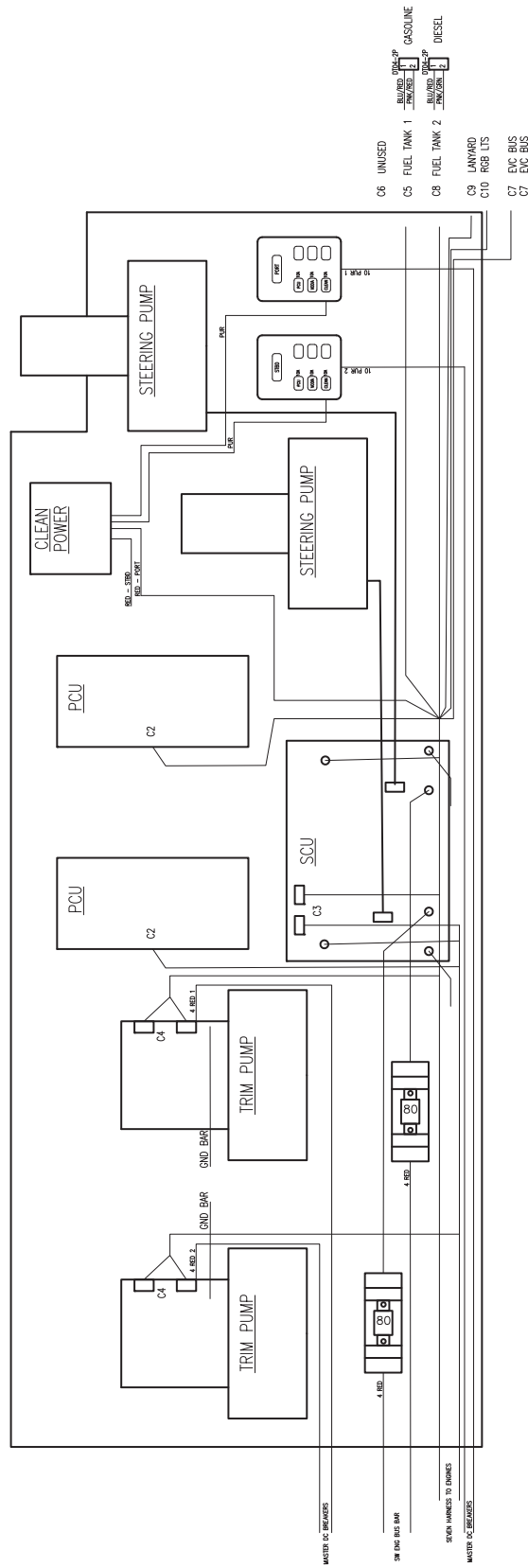

		PART NUMBER: FULL PART NUMBER: TRL #1/76
PRO. E. CO. INC. 1000 W. 44th ST. 2ND FLOOR N.W. PORTLAND, OR 97209 TEL: 503.281.1111 FAX: 503.281.1111		KB PANEL LOAD AND WIRING
DRAWN BY/DATE: CM/05-13-19 APPROVED BY/DATE:		37LSY-C01-B10017 15 OF 16

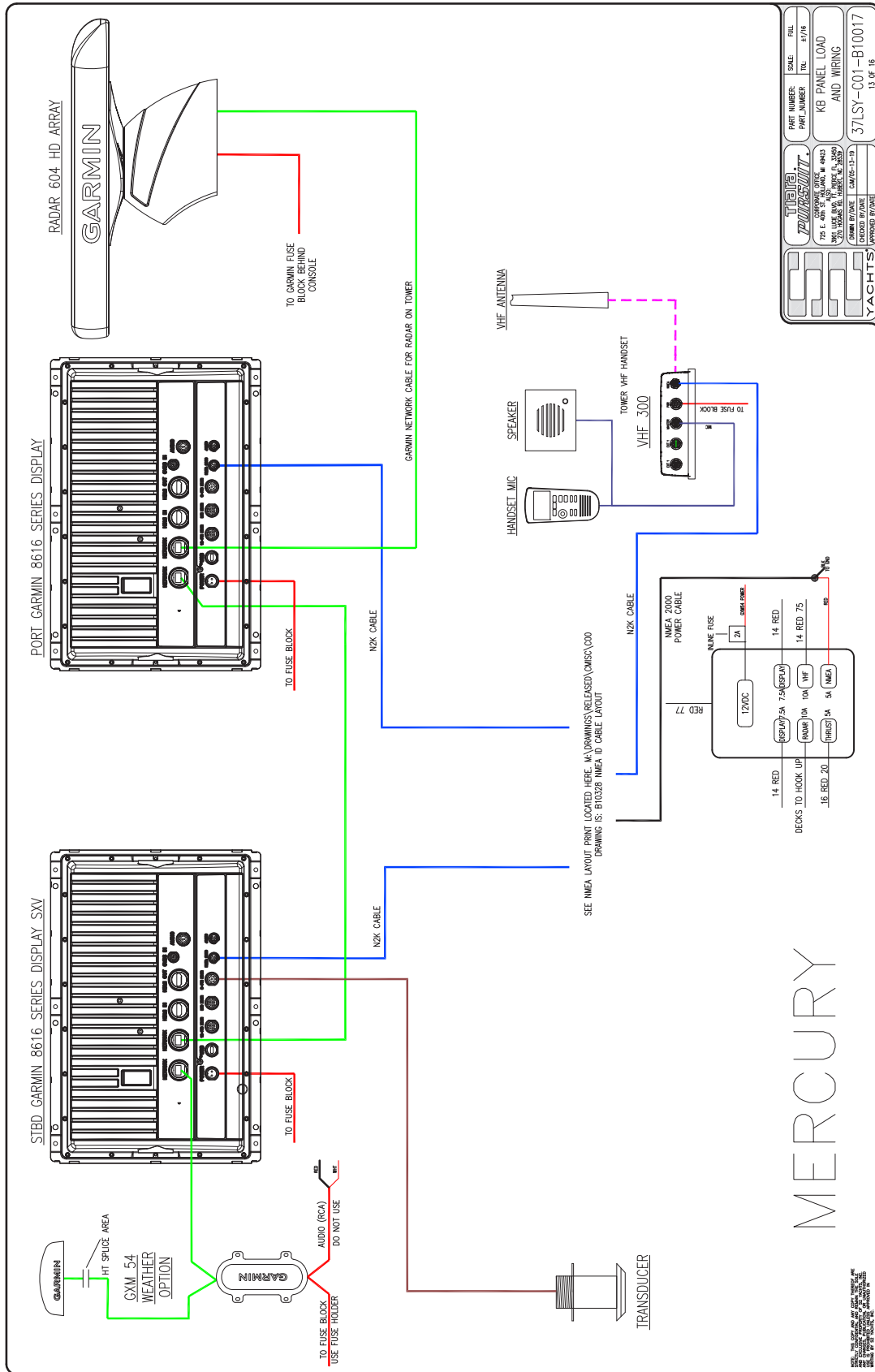

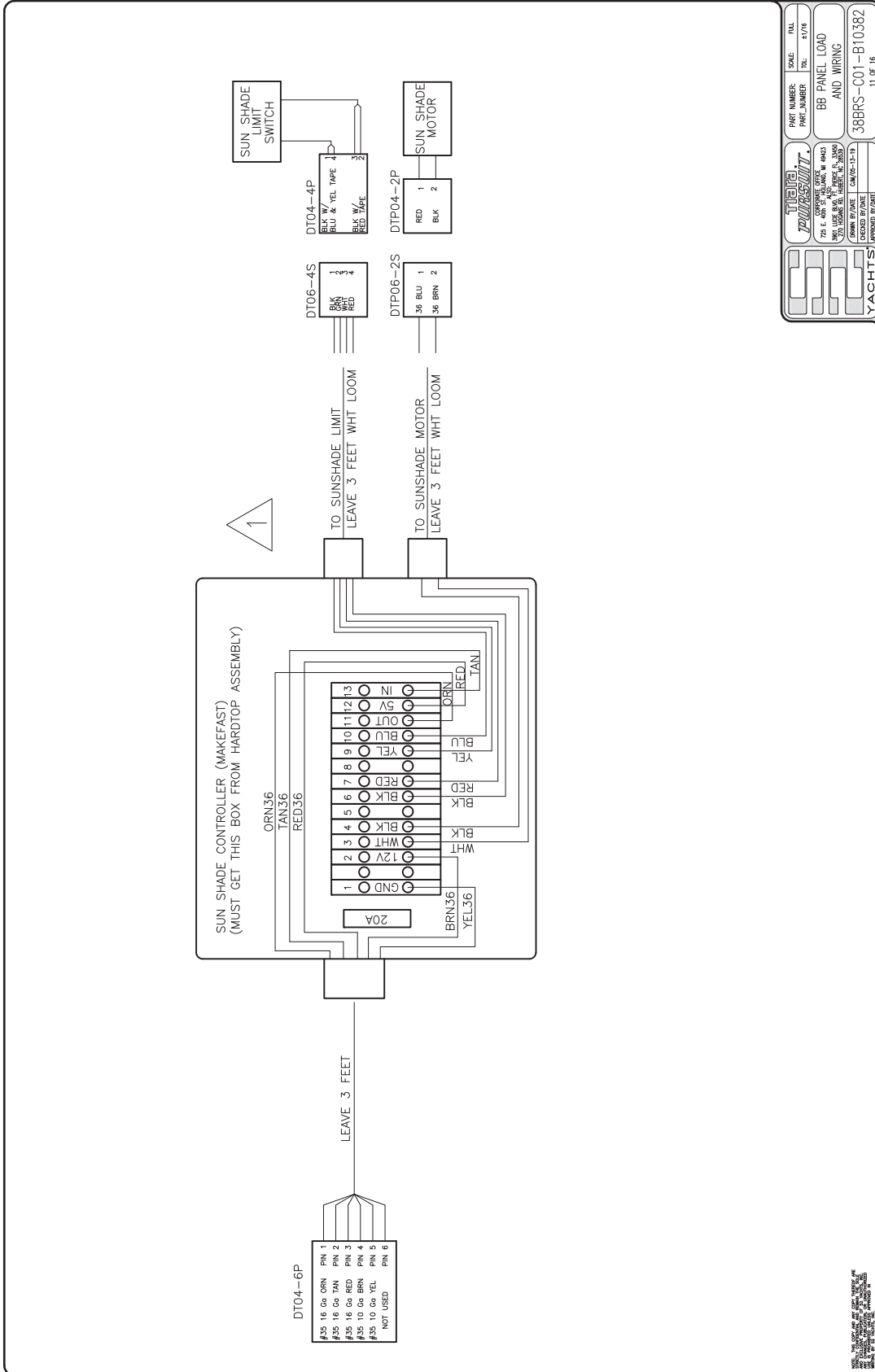

PART NUMBER: 38BRS-C01-B10382	
SCALE: 1/16"	TOL: ±0.010"
PART NUMBER: BB PANEL LOAD AND WIRING	
TITANIA YACHTS	
725 E. 40th St., Suite W 4403 Orlando, FL 32809 USA PHONE: 407-255-1311 FAX: 407-255-1312	
DESIGNED BY/DATE: []	APPROVED BY/DATE: []

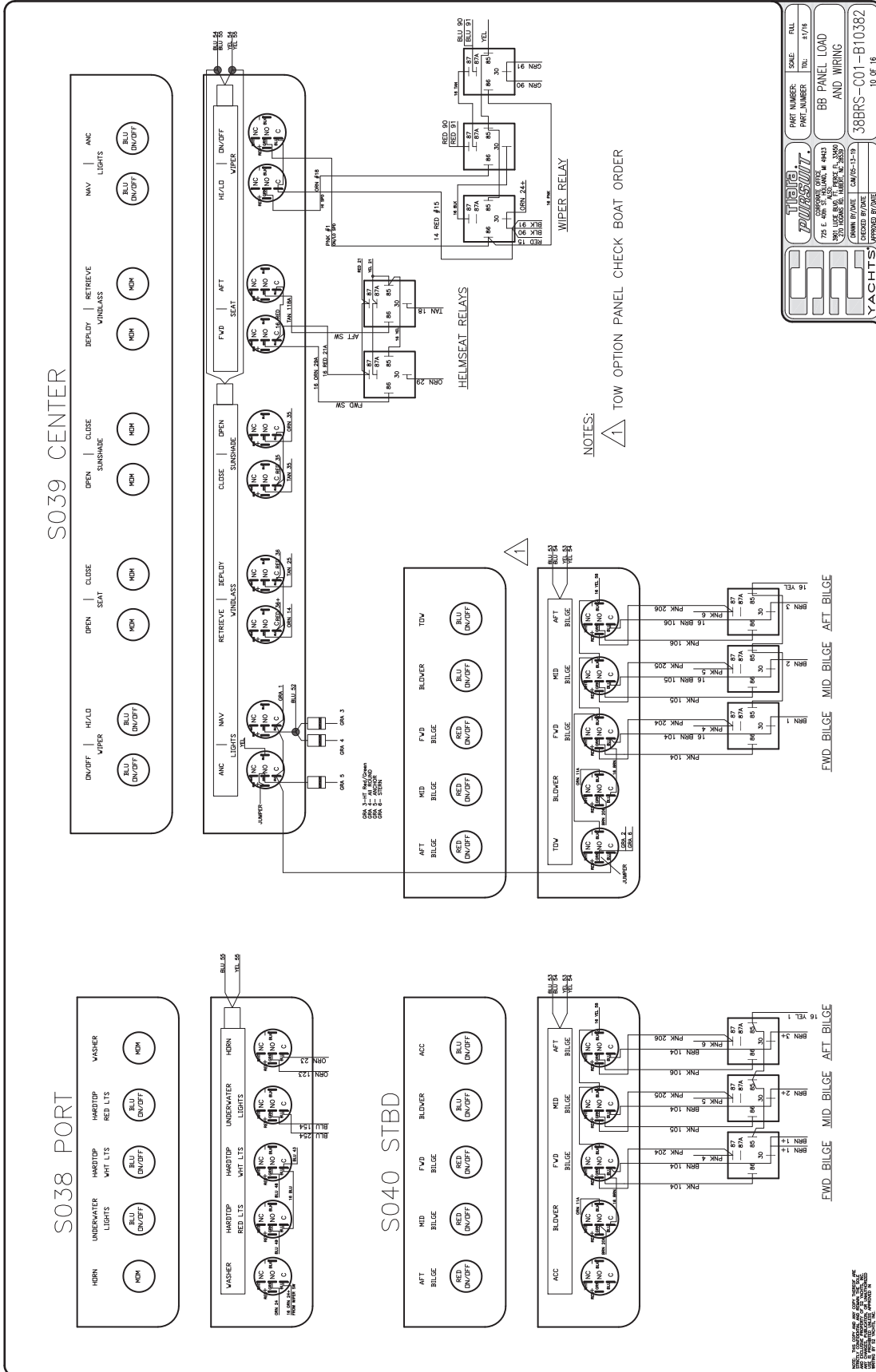

		PART NUMBER: 388RS-C01-B10382
SCALE: 1/8" = 1'-0"	ISSUE: 1/18	BB PANEL LOAD AND WIRING
DRAWN BY/AE: CAM/RS-13-13	CHECKED BY/AE:	10 OF 16

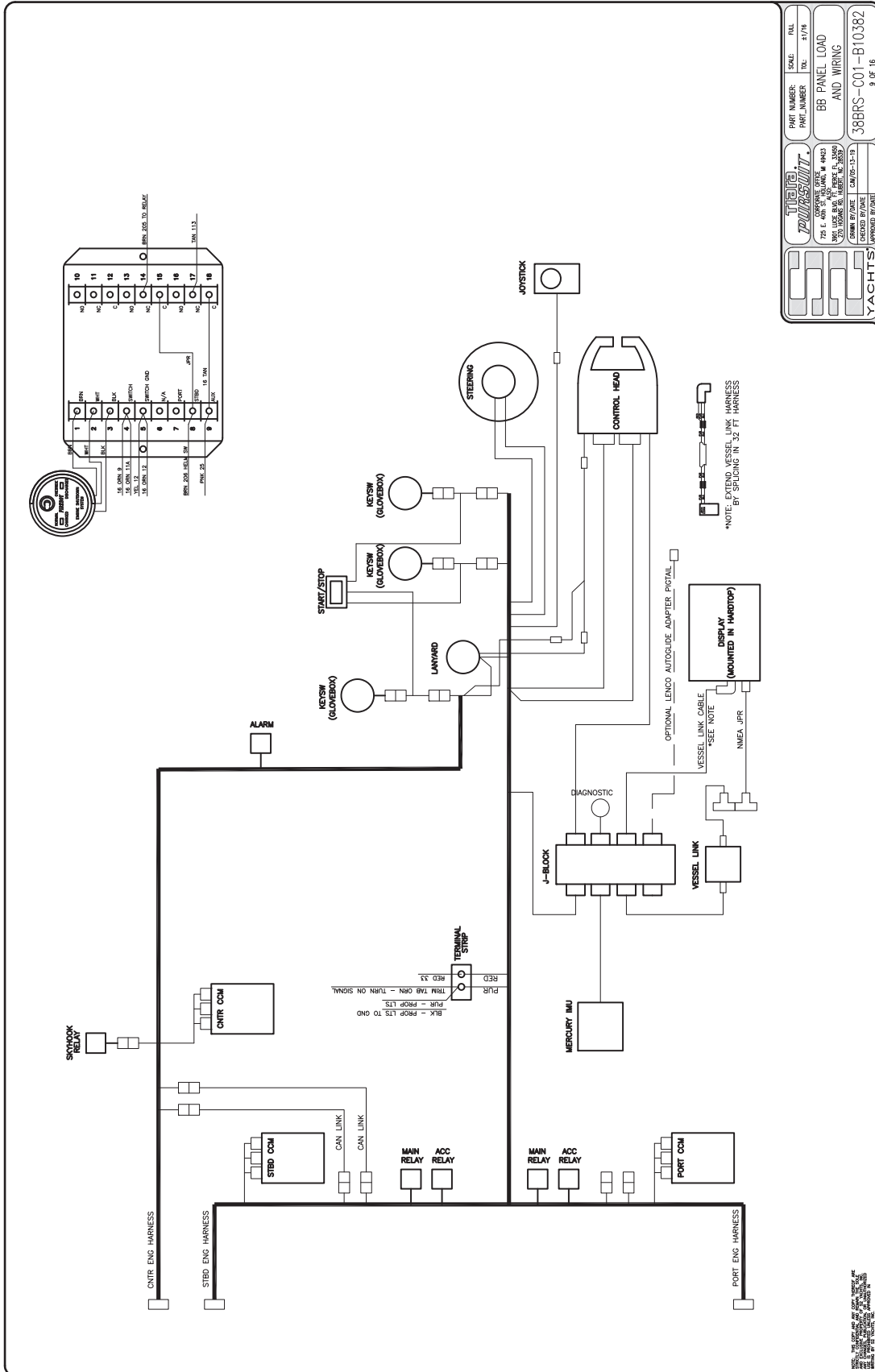

PART NUMBER:	SCALE: FULL
PART NUMBER:	TOL: ±1/16"
BB PANEL LOAD AND WIRING	
38BRS-C01-B10382	
9 OF 16	

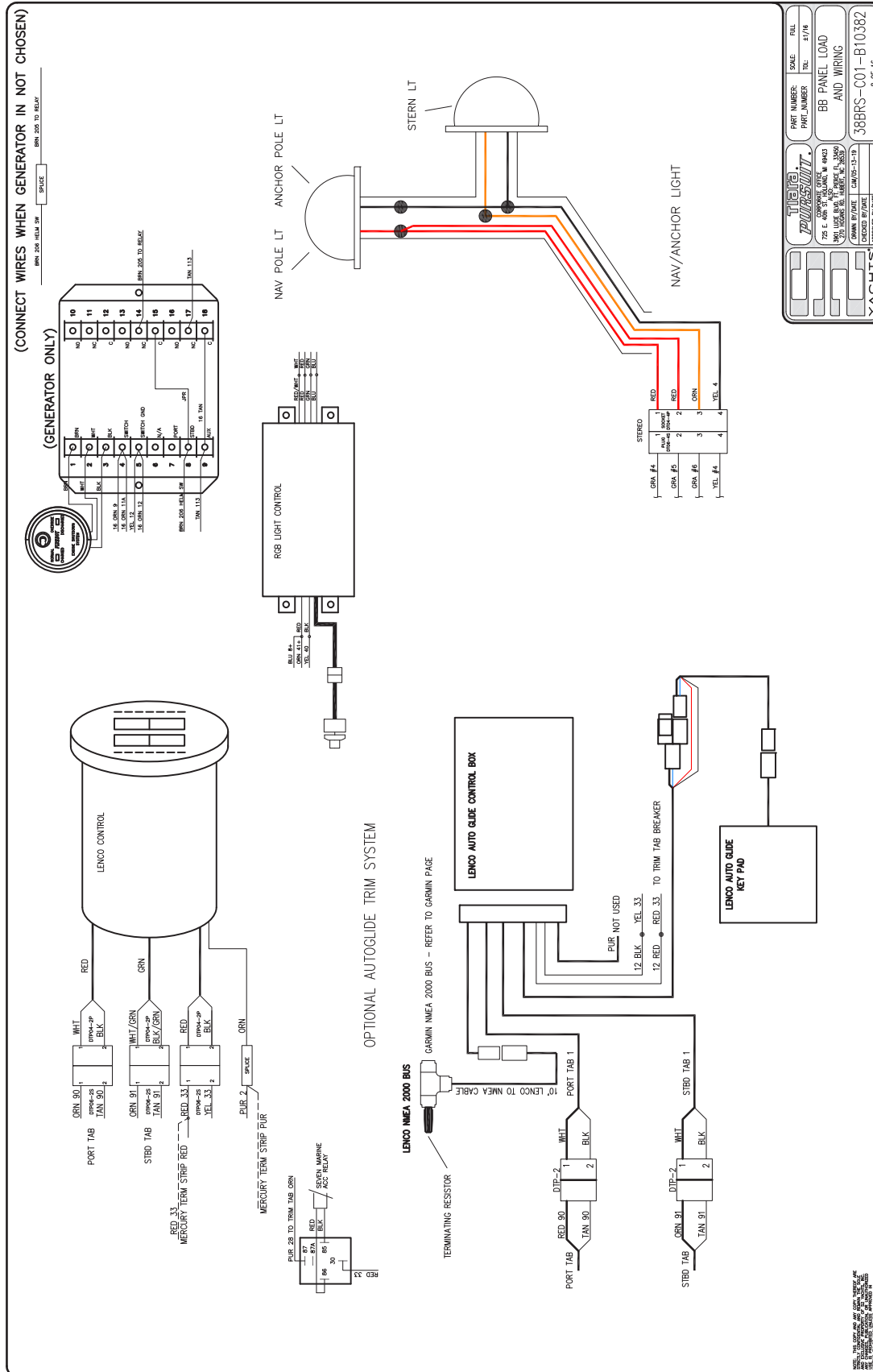

YACHTS

THE PowerSwitch

OPPOSITE SIDE OF PANEL IN #442
720 E. 40th ST. ANCHORAGE, AK 99501
707.536.8636 FAX 707.536.8630
WWW.POWER-SWITCH.COM

SCALE: FULL
PART NUMBER: 388RS-001-817/8
TOL: .817/8

BB PANEL LOAD
AND WIRING

388RS-001-B10382

REV: 5 OF 16

NOTES: THIS SCHEMATIC AND ALL OTHER SCHEMATICS ARE THE PROPERTY OF TIALARA YACHTS. NO PART OF THIS SCHEMATIC OR ANY OTHER SCHEMATIC MAY BE REPRODUCED OR TRANSMITTED IN ANY FORM OR BY ANY MEANS, ELECTRONIC OR MECHANICAL, WITHOUT THE WRITTEN PERMISSION OF TIALARA YACHTS. THE INFORMATION CONTAINED HEREIN IS INTENDED TO BE USED AS A GUIDE ONLY. THE USER MUST CONSULT THE TIALARA YACHTS WEBSITE FOR THE MOST CURRENT INFORMATION.

SEVEN/YAMAHA

NOTES:

OPTION BREAKER: CHECK ORDER

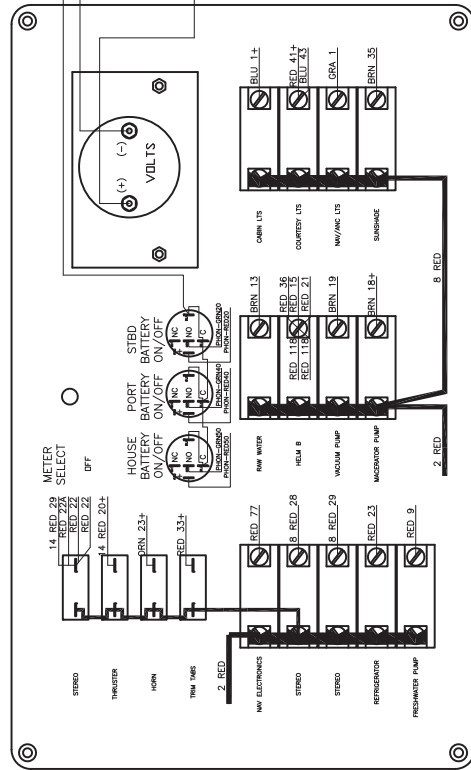
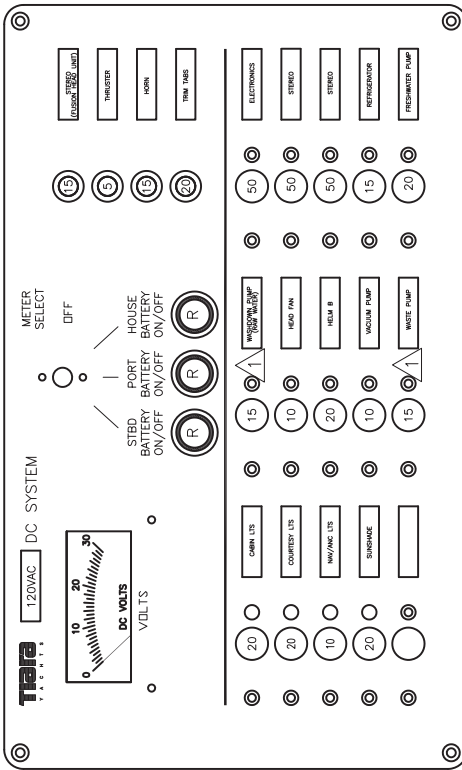
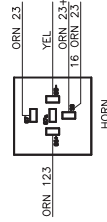
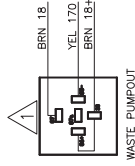
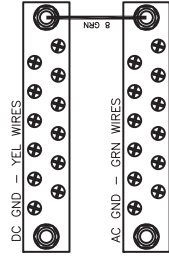
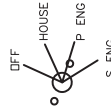

PHON-WHT22-SELICE NOT USED
 PHON-WHT46-SELICE NOT USED
 PHON-WHT58-SELICE NOT USED

DC FUNCTION 33714947

NOTE: TIGHTEN SCREWS NOT BEING USED

- POS. 1: 2-3, 4-3, 14-13
- POS. 2: 2-5, 4-7, 14-17
- POS. 3: 2-9, 4-11, 14-15

PART NUMBER: 38BFS-C01-B10382	
SCALE: FULL	REV: 5/1/16
BB PANEL LOAD AND WIRING	
TITARA YACHTS	
APPROVED BY/DATE	

MERCURY

NOTES:
 1. OPTION BREAKER: CHECK ORDER

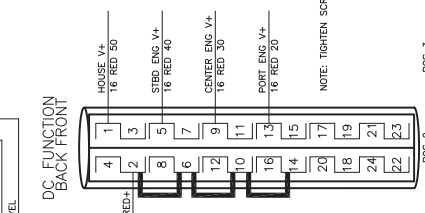
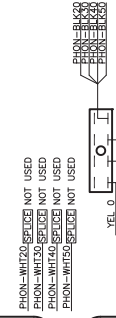
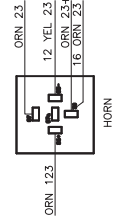
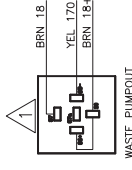
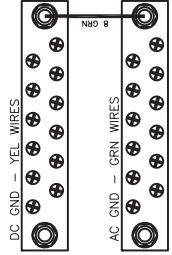

NOTE: TIGHTEN SCREWS NOT BEING USED

TITARA PARTS	
725 E. 40th St. ANCHORAGE, AK 99503	PHONE: 907.563.8800
725 E. 40th St. ANCHORAGE, AK 99503	FAX: 907.563.8800
1000 W. 11th St. ANCHORAGE, AK 99503	PHONE: 907.563.8800
1000 W. 11th St. ANCHORAGE, AK 99503	FAX: 907.563.8800
CHECKED BY/DATE	DATE
37LSY-C01-B10017	4 OF 16

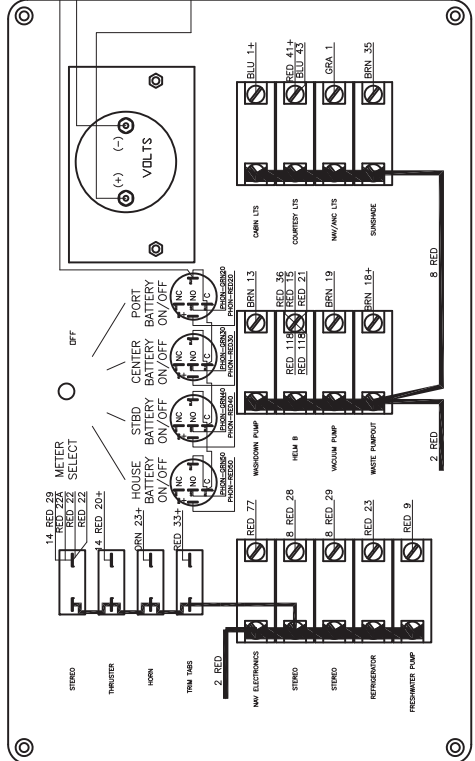
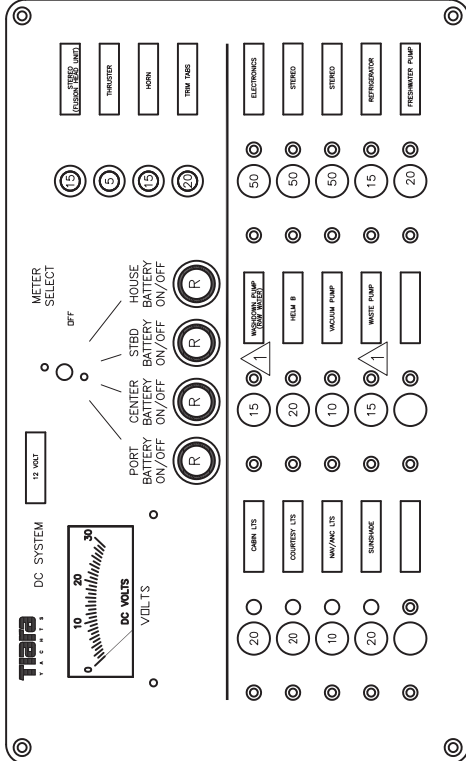

- EOS 1: 1-2, 1.3-1.4-1.6, 17-18
- EOS 2: 5-6, 9-10, 14-16
- EOS 3: 9-10, 15-14-16

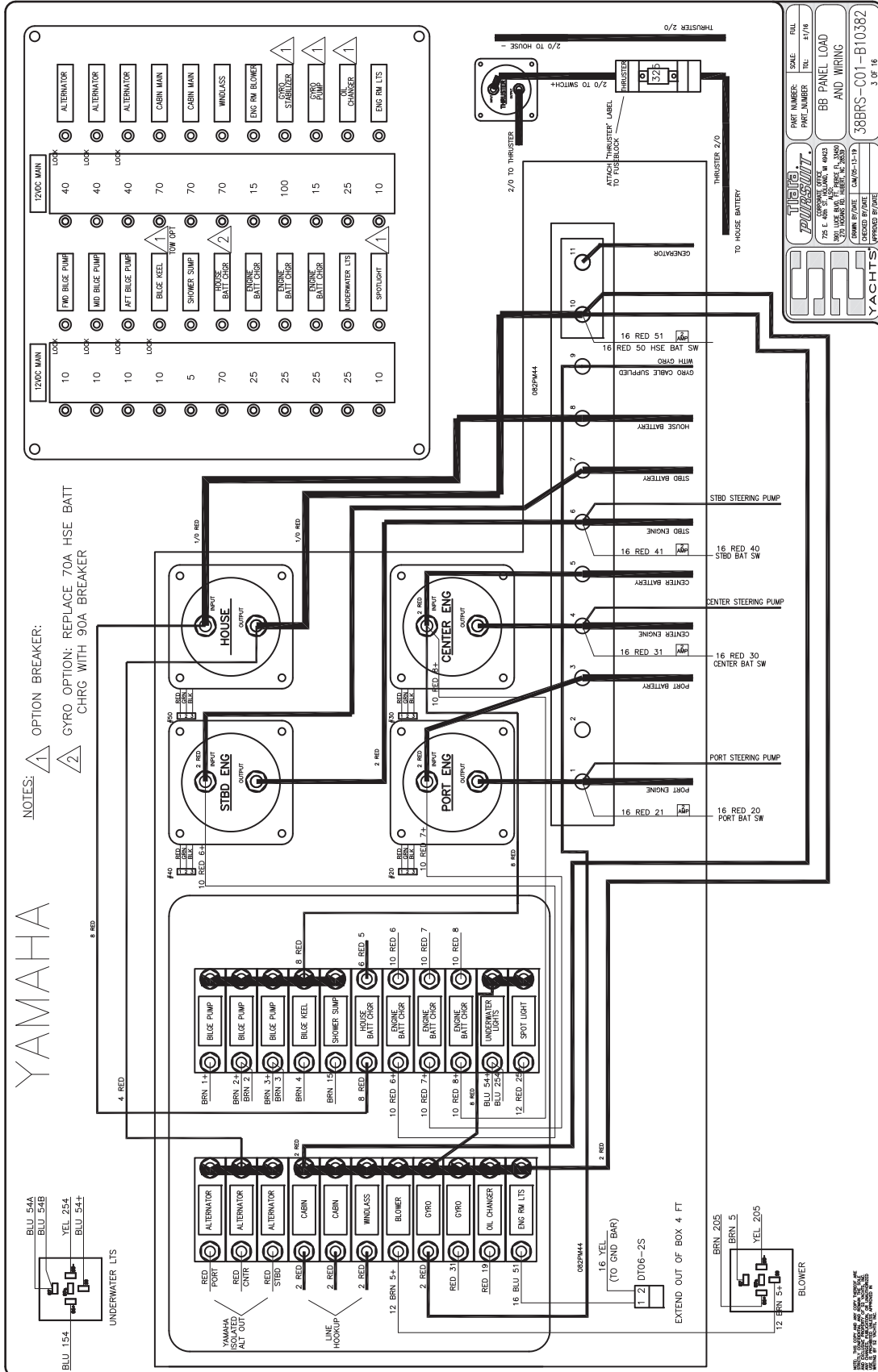

Tiara[®]

Y A C H T S

725 E 40th Street, Holland, MI 49423 | 616.392.7163
tiarayachts.com



AMERICAN MADE